

PREFACE

This manual is designed to provide necessary guidelines for optimal fabrication, installation, and performance of LOTTE ADVANCED MATERIALS Staron® solid surface products, per their unique chemical composition and properties.

Though the information contained herein is deemed reliable, none of the contents—including but not limited to the instructions, techniques, graphics, and recommendations—is to be understood as implying legal liability of fitness for a specific purpose, any other type of warranty, or being complete or absolute in its range and nature of information. Depending on the user's particular application, all necessary measures must be taken to verify and test the adequacy for such needs or application at his/her discretion.

Any information or recommendation herein is strictly for purposes of reference and as such, LOTTE ADVANCED MATERIALS Inc. and its affiliates assume no responsibility for its suitability or accuracy or the use of such information for products other than LOTTE ADVANCED MATERIALS Staron® solid surfaces.

TABLE OF CONTENTS

SAFETY HANDLING AND STORAGE

- 1.1 Handling Staron® Sheets
- 1.2 Handling Staron® Sinks & Bowls
- 1.3 Storing Staron® Sheets
- 1.4 Storing Staron® Sinks & Bowls

QUALITY INSPECTION

- 2.1 Staron® Sheet Quality Inspection
- 2.2 Staron® Sink & Bowl Quality Inspection

ADHESIVE

- 3.1 Product Description
- 3.2 Features & Benefits
- 3.3 Physical Properties (Uncured)
- 3.4 Physical Properties (Cured)
- 3.5 Handling and Application
- 3.6 Dispensing Adhesive
- 3.7 Storage and Shelf Life
- 3.8 Helpful Hints

TOOLS AND ACCESSORIES

- 4.1 Basic Fabrication Shop
- 4.2 Tool Check List

SITE PREPARATION

- 5.1 Site Inspection
- 5.2 Leveling
- 5.3 Required Tools

TEMPLATES

- 6.1 Measurement Templates
- 6.2 Luann Strip Templates
- 6.3 Cardboard Templates
- 6.4 Digital Templates
- 6.5 Tools Needed

SEAM PLACEMENT

- 7.1 Planning
- 7.2 Positioning

CUTTING

- 8.1 Tools Needed
- 8.2 Overview

SEAMING

- 9.1 Tools Needed
- 9.2 Wavy Edge Bit
- 9.3 Straight Cut
- 9.4 Mirror Cut
- 9.5 Edge Preparation
- 9.6 Seam Adhesive
- 9.7 Ski Routing and Sanding
- 9.8 Seam Plate

EDGE DETAILS AND BUILDUPS

- 10.1 Stacked Edge
- 10.2a Drop Edge (Standard)
- 10.2b Drop Edge (Rabbet Method)
- 10.3 V-Grooving
- 10.4 Inside Corner Buildup
- 10.5 Decorative Edge Profile

INLAYS

- 11.1 Overview
- 11.2 Hard Inlays
- 11.3 Poured Inlays

SINK & BOWL CUTOUTS

- 12.1 Tools Needed
- 12.2 Making Cutout Templates
- 12.3 Making Cutouts Using Templates
- 12.4 Making Cutouts Freehand

COOKTOP CUTOUTS

- 13.1 Cooktop Templates
- 13.2 Cooktop Cutout
- 13.3 High Strength Support
- 13.4 Final Rout
- 13.5 Sanding
- 13.6 Potential Problems
- 13.7 Prevention

TABLE OF CONTENTS

SUPPORT

- 14.1 Countertop Support
- 14.2 Overhang Support

STARON® SHAPES

- 15.1 Handling Staron® Sink & Bowl

FASTENING TO STARON®

- 16.1 Stainless Steel Sinks
- 16.2 Cast Iron Sinks
- 16.3 China Bowls
- 16.4 Wood Insert
- 16.5 Wood Edge
- 16.6 Handicap Bar & Handles Shower Doors
- 16.7 Soap Dishes Shower Caddies
- 16.8 Tiles Hot Pot Areas

BACKSPASHES

- 17.1 Loose Backsplash
- 17.2 Coved Backsplash
 - 17.2-1 Method (I)
 - 17.2-2 Method (II)
 - 17.2-3 Method (III)
 - 17.2-4 Method (IV)
- 17.3 Full Height Backsplash

FINISHING AND POLISHING

- 18.1 Finishing
- 18.2 Polishing

INSTALLATION

- 19.1 Transportation
- 19.2 Site Preparation
- 19.3 Carrying & Positioning
- 19.4 Dry Fitting
- 19.5 Seam Plate
- 19.6 Faucet Holes
- 19.7 Final Placement
- 19.8 Anchoring Dishwasher
- 19.9 Preparing Cooktop Cutout
- 19.10 Do's and Don'ts

VERTICAL APPLICATIONS

- 20.1 Overview
- 20.2 Fabrication & Installation

COMMERCIAL APPLICATIONS

- 21.1 Food Service Application (Hot Wells)
- 21.2 Food Service Application (Cold Wells)

THERMOFORMING

- 22.1 Material Preparation
- 22.2 Mold Preparation
- 22.3 Oven
- 22.4 Oven Calibration
- 22.5 Thermoforming
- 22.6 Thermoforming Checklist

REPAIR

- 23.1 Introduction
- 23.2 Inside Corner Repair
- 23.3 Bevel Repair
- 23.4 Solid Surface Sink Replacement

RECOMMENDED TOOLS

- 24.1 Recommended Tools

1.1 Handling Staron® Sheets

Staron® Sheets are usually transported on pallets.

Staron® pallets should be unloaded with a forklift or other lifting device capable of handling following dimensions safely.

	Staron® Sheet	Empty Pallet	10 Staron® Sheets + Pallet
Weight (lbs)	121	55	1,265
Length (in)	145	146	146
Width (in)	30	32	32
Height (in)	0.5	6.8	11.8



[1.1 - A]



[1.1 - B]

TIP

Forklift should have minimum of 6' forks.

If lifting device is not available, Staron® Sheets can be unloaded manually. However, it is very important to follow special procedures for your safety :

- Handle one sheet at a time
- Sheet should be handled on the edge
- Carry Vertically
- Always have heavy-duty protective gloves and proper safety shoes.
- Two people

TIP

Extreme temperatures will affect the product. Make sure to use caution when handling at a temperature below 40°F (4°C). For your safety, always use common sense and follow the safety guidelines when handling Staron® Sheets. Sheets should be carried one at a time on edge with one hand under to support and one hand for control.

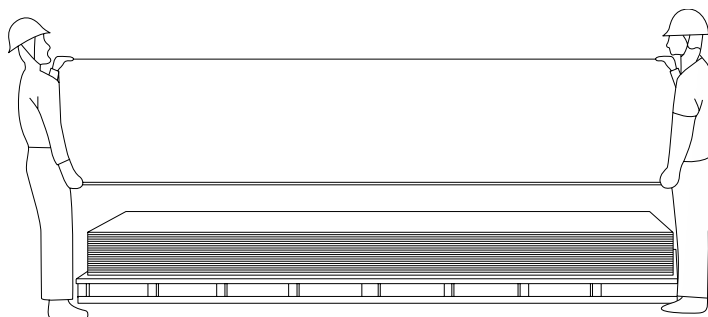

[1.1 - C]

1.2 Handling Staron® Sinks & Bowls

Staron® Sinks and Bowls should be handled carefully according to the instructions on the package. Although Staron® Sinks and Bowls are packaged to give maximum protection, it is important to use caution when handling them.

TIP

Staron® Sinks and Bowls should not be stacked more than 6 boxes high.
Remember! To reduce the chance of damage, do not drop, apply pressure, or place heavy loads on top.

1.3 Storing Staron® Sheets

There are two ways of storing Staron® Sheets to avoid warping or sagging.

Staron® Sheets are most effectively stored at temperatures between 59 ~ 73°F (15 ~ 23°C) and should be kept in a dry and well ventilated indoor area. Avoid exposure to moisture during storage.

- Staron® Sheets should be stored flat and evenly supported as illustrated in (Figure 1.3 - A).

Note

Staron® Sheets should be stored for easy access where Lot Numbers and Colors can be identified.

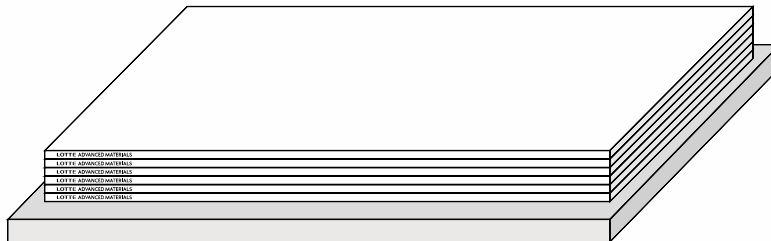

[1.3 - A]

TIP

Special care should be taken in storing Staron® Sheets to prevent them from warping and sagging.

Storage system, which allows easy accessibility, handling, and Lot identification, are the key.
Exposure to moisture and direct sunlight during storage may damage the sheets.

Staron® Sheets should not be allowed to be stored in a wet environment.

1.4 Storing Staron® Sinks & Bowls

Staron® Sinks and Bowls should be handled carefully according to the instructions on the package. Although Staron® Sinks and Bowls are packaged to give maximum protection, it is important to use caution when handling them.

TIP

Staron® Sinks and Bowls should not be stacked more than 6 boxes high.

Remember! To reduce the chance of damage, do not drop, apply pressure, or place heavy loads.



[1.4 - A]

2.1 Staron® Sheet Quality Inspection

The goal at LOTTE ADVANCED MATERIALS Staron® is to provide the highest quality materials to our fabricators to insure customer satisfaction.

As a result, we check and recheck each individual sheet to meet our rigorous quality standards.

However, it is the fabricators' responsibility to conduct a visual inspection for defects and color match for every sheet they work with.

TIP

After thorough inspection of the sheet, if you find any defect which will greatly increase your fabrication time, please contact your Staron® Distributor.

Your Staron® Distributor will answer any question and provide assistance on Staron® Solid Surface Products.

If you are unsure of the quality of the material, please contact your Staron® distributor for service.

Note

LOTTE ADVANCED MATERIALS Staron® will replace materials which do not meet our product specification when delivered. However, LOTTE ADVANCED MATERIALS Staron® will not be responsible for any labor charges incurred during or after fabrication on the defective materials.

Table 2.1-A shows some of the standards set to help with the inspection upon receipt of Staron® Sheets (at the time of delivery).

Inspection Standards	Specification
Broken / Cracked	None
Color Difference (Sheet to Sheet)	LOTTE ADVANCED MATERIALS does not guarantee color match. This characteristic is inherent with Solid Surface products in the industry. Checking for color match before fabrication is not only required, but very highly recommended. Requirements on Color Match: - Use sheets from same pallet - Check and use from same Lot # and stay with in specified range of sequence - Trial Color Match(Dry-fit test)
Color Difference (With same Sheet)	
Warping	Less than 1.6mm or 1/16" (approx.)
Pit Hole	None
Foreign Particle	0.30mm~0.34mm size : Less than 5 per sheet 0.35mm~0.60mm size : Less than 2 per sheet
White Spots	0.30mm~0.34mm size : Less than 5 per sheet 0.35mm~0.60mm size : Less than 2 per sheet
Concave	Receding of Particulate (None)
Tapered Edge	Less than approx. 1.19mm or 3/64" (approx.)
Discoloration	None

[2.1 - A]

Note

Please inspect carefully upon receipt of the Staron® product. LOTTE ADVANCED MATERIALS Staron® replacement policy does not allow for any labor charges incurred during or after fabrication on the defective materials.

• Metallic series

Metallic series has the unique patterns which contain pearl particulates that are shaped flat and tend to float on the surface. These particulates come with directional pattern due to unique distribution method in production. As a result, reflections in particulates may vary depending on light and view angles, so it requires special attention to sheet orientation and not all standard fabrication technique are applicable.

- Contact your local sales or distributors/fabricators for more information.

• General Installation

1. Be sure to check dye lot numbers upon delivery of the product for color-match.
Sheets that are to be seamed together must be the same lot number.
 2. The following checklist must be completed and the job physically inspected before a Distributor representative is sent to inspect a claim.
 3. The tops of the cabinets must be flat and true to within $\frac{1}{8}$ "(3mm) of a flat surface.
 4. Clean surfaces with denatured alcohol before applying adhesive to prevent bonding failure.
 5. Provide only perimeter support (top edges of cabinets with or without build-up strips). Use only dime size dabs of flexible adhesive (clear silicon) every 12 ~ 18" (305 ~ 457mm) to fasten Staron® tops to the perimeter.
 6. Joint adhesive may be used to build large solid walls of Staron®. Be sure to allow proper clearance between Staron® and walls for expansion and contraction.
The gap and size of the area to which the adhesive will be applied depends on the expected temperature change.
 7. Never install mechanical fasteners (screws, nails, etc) into Staron®.
 8. Must leave a piece of color match materials (the same lot #) from each counter on the job for future repairs (minimum 2sq.ft.).
 9. Staron® in $\frac{1}{4}$ " (6mm) thickness is not recommended for use on countertops or other horizontal surfaces.
 10. Support overhangs exceeding 6" (152mm) for $\frac{1}{2}$ "(12mm) Staron® material.
 11. All seams should be supported by 4"(102mm) minimum seam plate, both edges should be beveled at 45 ~ degrees.
 12. Radius all inside corners to a minimum of $\frac{1}{2}$ " (13mm) radius.
This will reduce stress in the countertop. Larger radius give more protection.
 13. Do not install Staron® over under-layment (full substrate) or over old countertops. Integral dust covers may be left in place if removal is unacceptable to the customer.
 14. In wet wall installations, leave a $\frac{1}{2}$ " (13mm) air gap at the bottom, to prevent water leaks from wicking up between the Staron® and the wall.
 15. Use only routers. Use $\frac{3}{8}$ " (10mm) or larger diameter bits.
 16. Remove all nicks, tool marks, etc. Use 150 grit (80 or 60 micron) or finer sandpaper.
 17. Support within 3" (76mm), but no closer than 1" (25mm), from the edge of the cutout.
 18. Reinforce all shop and field seams.
 19. Seams should not go through cutouts. In addition, seams should be at least 3" away from any cutouts.
 20. Leave at least $\frac{1}{4}$ " (6mm) clearance space on all sides to allow cooktop/sink expansion. Clearance space should be as big as possible.
 21. Use only approved adhesives.
 22. Do not rigidly adhere Staron® to other solid surface products.
 23. High strength corners are required on all cutouts made for heat generating appliances.
 24. Avoid 'stress risers', (defined as a notch, gap, offset or sharp inside corner in a solid surface assembly).
Stress risers weaken the overall assembly, eventually causing cracks in solid surfacing.
 25. Avoid placing seams at inside or outside corners. Seams should be placed at least 1" (25mm) away from inside and outside corner radiuses to prevent cracks. Seams are potential weak point where crack(s) can start.
Seams that are located further away from the corner can better prevent crack(s).
 26. Apply Heat-Conductive Aluminum Tape (One Layer of 4 mils, at least 2"wide, ex: 3M 425 Aluminum Foil Tapes or similar) in recommended fashion to cook-top and around heat sources in family housing to protect from heat damage and thermal stress. Apply Insulating Felt Tape for use with drop-in food wells used in commercial food service applications to insulate Staron® product from hot or cold appliance.
- ❖ if a cook-top is to be mounted to Staron® product, be sure that there is room inside the cabinet to hold the top and any pop-up vents that will be installed with it

• Fabrication and Installation Check List:

Residential 10-year limited warranty of Staron® solid surface products will not cover damages caused by improper fabrication and installation. The following list is a mandatory check list for fabricators when working with Staron® Solid Surface products.

• Tub and Shower Surround Installation

1. Use water-resistant wallboard. Do not apply directly to masonry that could become moist.
2. Wallboard must stop ½" (13mm) above tub or shower flange to prevent damage caused by wicking.
3. When installing over tile or other wall material it must be clean, sound and dry.
4. Before cutting holes make sure that sheet is firmly supported.
5. Cut all holes with router or hole saw.
6. Provide plumbing holes ¼" (6mm) larger than hardware or fixtures.
7. All corners of cutouts must be round and edges smooth.
8. Wipe walls and sheets with denatured alcohol before applying adhesive.
9. Use 100% silicone.
10. Leave 1/16" (1.6mm) space for caulking between Staron® and tub flange; also for caulking between sheets at corners.
11. Wipe joints with denatured alcohol before caulking.
12. Force caulk into joints with pushing motion.

2.2 Staron® Sinks & Bowls Quality Inspection

Table 2.2-A shows some of the standards set to help with the inspection upon receipt of Staron® Shapes (at the time of delivery).

Inspection Standards	Specification
Broken / Cracked	Make sure to check for any cracks, especially around drain holes. Any chips or cracks will affect the integrity of the sinks and bowls.
Color Order	Check to see if the delivered goods are correct.
Correct Size	Remember, there are many sinks and bowls with similar designs. Measuring for correct size is recommended.
Accessory	Make sure all accessories are included in the package.
Correct Specification	Please check to see for correct dimension.
Structure uniformities	None
Foreign Particle	Less than 2
Pit Holes	Less than 2
Overflow	Check for correct location and placement.
Drain Holes	Check for correct location and dimension
Discoloration	None
Color Difference (Shape to Sheet)	Color match between shape and sheet is not guaranteed.

➔ Note

Please inspect carefully upon receipt of the Staron® product. LOTTE ADVANCED MATERIALS Staron® replacement policy does not allow for any labor charges incurred during or after fabrication on the defective materials.

3.1 Product Description

Staron® Methyl Methacrylate Adhesive is a specially formulated 10:1 ratio decorative solid surface adhesive. Staron® adhesive is translucent, U.V. Stable, non yellowing and readily accepts pigments for color matching applications.

It offers excellent adhesion to all types of solid surface products, including densified cast polyester, acrylic, and formulations that include both acrylic and polyester blends. Staron® adhesive has a working time of 10~15 minutes and products seamed with Staron® adhesive may be handled 20 minutes after gel time.

Fabrication of bonded parts (sanding, finishing, routing) may take place within one hour after assembly of parts.

Staron® adhesive has excellent performance in U.V light, impact resistance, wear resistance, scuffing, staining, and in resisting water penetration, including boiling water.

3.2 Features and Benefits

• Product Description

- 100% Reactive
- Translucent
- Color Matchable
- Fast Room Temperature Curing
- U.V. Stable
- Sandable
- Phthalate Free
- Non Yellowing

3.3 Physical Properties (Uncured)

	Part A Adhesive	Part B Activator
Viscosity (Centipoise) - Brookfield RVF (Spindle 7; 20 rpm)	20,000~22,000	6,000~8,000
Color	Clear	Off-White
Weight (pounds per gallon)	9.1	9.5
Mix Ratio by Volume	10	1
Flash Point	50°F(10°C)	
Mixed Viscosity (Centipoise)	16,000 ~ 20,000	
Open Work Time (Minutes)	10 at 72°F(22°C)	
Assembly Time (Minutes)	15 at 72°F(22°C)	
Fixture Time (Minutes)	25 at 72°F(22°C)	
Solvents that are in product	None	

3.4 Physical Properties(Cured)

Butt Joint	Cast Polyester	----- 4,000 psi
	Cast Acrylic	----- 4,000 psi
	Cultured Marble	----- Exceed Product
Compression Shear	Cast Polyester	----- Exceed Product
UV Light Resistance		----- Very Good
Thermal Resistance		----- Very Good
Operating Temperature Range		----- 40°F~ 250°F (4°C ~ 121°C)

3.5 Handling and Application

Staron[®] Adhesive Part A is flammable, containing methacrylate esters.

Keep containers closed after use. Avoid eye and skin contact. Wash with soap and water after skin contact. In case of eye contact, flush with water for 15 minutes and get immediate medical attention. Harmful if swallowed.

Keep out of the reach of children. Keep away from heat, sparks, and open flames.

NOTE: Because of the rapid curing features of this product, large amounts of heat are generated when large masses of material are mixed at one time (bond joints and thicknesses greater than 1/8" (3mm) should be avoided).

The heat generated by the exotherm resulting from the mixing of large masses of adhesive can result in the release of entrapped air and volatile components as evidenced by gassing.

3.6 Dispensing Adhesive

Staron[®] Adhesive is generally applied using pre-measured cartridges or Paks.

Hand-held guns (manual or pneumatic) are generally used with the premeasured cartridges. To assure maximum bond strength, clean surfaces must be mated within the specific open time. Use sufficient material to insure 100% joint fill when parts are mated and clamped. Avoid over tightening of seam. Use spring activated clamps. All adhesive application, part positioning, and fixturing must occur before the assembly time of the mix has expired. After indicated assembly time, parts must remain undisturbed until the fixture cure is reached. Avoid contact with copper, brass, or copper alloys in all fittings, pumps, etc. Seals and gaskets should be made of Teflon, Teflon coated PVC foam or polyethylene. Avoid the use of Vitron, BUNA-N, Neoprene or other elastomers for seals or gaskets. Cleanup is best performed before the adhesive has cured. If the adhesive is already cured, careful scraping, followed by a solvent wipe may be the most effective method of cleanup.

Application of adhesive at temperatures between 60°F (16°C) and 90°F(32°C) will insure proper cure speeds.

Temperatures below 45°F(7°C) will slow cure; above 90°F(32°C) will speed cure.

3.7 Storage and Shelf Life

All Staron[®] Adhesive should be stored in a cool, dry place when not used for a long period of time. Staron[®] Adhesive has a various shelf life which is 24months for Tube and 18months for cartridge from manufactured date or more when stored at room temperature 72°F(22°C) in their original containers. Shelf life may be extended by refrigeration.

This information is being supplied by the Manufacturer of Staron[®] Adhesive, and all information is provided to the best of the Manufacturer's knowledge. The Manufacturer makes no representations or warranties of any kind concerning this data or information on this data sheet. Due to conditions outside of the control of the Manufacturer, the Manufacturer does not accept liability for results obtained. Any questions concerning this information or product use should be directed to the manufacturer of Staron[®] Adhesive.

3.8 Helpful Hints

Helpful hints on using and storing Staron® Adhesive

Always store adhesive in an upright position. Adhesive should be stored in the cooler areas of the shop, with temperatures 50°F~70°F (10°C~21°C) Storing the adhesive in a separate refrigerator (from lunches, snacks, drinks), will prolong the life of the adhesive. Do not freeze the adhesive.

When using a fresh, unopened tube, squirt a little material out (with no tip attached) to ensure that you have both adhesive and catalyst flow. Many fabricators squirt this out into their trash can or onto a piece of paper. Then attach a tip, squirt out into the trash a little bit of adhesive and you are ready to begin seaming or making buildups.

After you are done using the adhesive, many fabricators leave the tip on the tube. The material will set up in the mix tip, but will not set up in the cartridge or in the feed chamber. You can re-store the tube with tip attached in the upright position. Then when you need to reuse the tube of adhesive, simply take off the set up tip, and squirt a little out to make sure you have adhesive and catalyst flow. Attach a new clean tip onto the cartridge, squirt a little adhesive out of the tip into the trash and you are ready to begin seaming.

Helpful hints when using Staron® Adhesive to make seams or buildups

Always use mirror cutting techniques to cut the seam. Routed mirror cut seams provide the cleanest seams and often help reduce gaps due to router chatter.

Always dry fit seams. If you can't see the seam when it's dry fitted, you will probably not see the seam once adhesive has been applied. For best bonding strength, use 150 grit (80 or 60 micron) sandpaper to "rough up" the seamed areas. Many fabricators use a block of wood and adhere the 150 grit (80 or 60micron) sandpaper to the block and gently swipe the seamed area roughing up the edges to be seamed. But be careful not to round out the top edges of the seamed areas. It is always best to wipe the seam with denatured alcohol immediately prior to seaming in order to remove dust or oily films left by your hand.

It's always best to use spring clamps or Dani Clamps when making seams or buildups. Jorgeson clamps or screw clamps can put too much pressure on the seam squirting out the adhesive too much. It is always best to lay two to three small beads down, rather than one large thick bead. Apply adhesive in a small bead from one end of the build up or seam to the other in a back and forth motion. Two to three passes maximizes the chance of full of proper catalyst / adhesive mix.

4.1 Basic Fabrication Shop

Similar to other industries, Staron® Fabricators vary on the brand of tools they like and use in their shops.

The following are the recommended tools to be used on Staron® 100% Acrylic Solid Surface materials.

It is up to the fabricator to choose the brand of tools to fit their needs.

However, it is very important to follow the guidelines on fabrication methods and tools that are not recommended or prohibited.

4.2 Tools Check List

- Router
 - Trim Router
 - 1 ½ H.P. Router
 - 3 ¼ H.P. Router
- Hole Saw Kit
 - 1½ ", 1¼ ", 1⅜ ", 1½ "
- Drill
- Hot Glue Gun
- Glue Stick
- Straight Edge
- Sander
 - 6" with vacuum
 - Stiff pad and contour pad
- Jig Saw (For making Templates only, Do Not use on Staron®)
- Adhesive Gun
- Circular Saw
- Belt Sander
- Grinder
- Bar Clamps
 - 12"x 4" throat
- 2" Spring Clamps
 - 200 to start (4 for every foot of edge buildup)
 - daniclamps - PVC pipe type (4 for every foot of edge buildup)
- 4" Spring Clamps
 - For seams (depending on seaming method)
- Carpenters Square
- 4" Drywall Square
- ½" Luan or Cardboard for Templates
- Caulk Gun
- Spray Bottle
- Denatured Alcohol
- Vacuum
- Aluminum Tape - For Cook tops and Slide in Ranges
- Micron Sand Paper - 100, 80, 60, 30
- Scotch Brite™ - (Maroon and Grey)
- 31/32 AC Fir Plywood - Buildup Strips

- Silicone
 - Clear for general purpose
 - Colored for splashes
- Router Bit
 - Bowl Bit
 - 2" Straight Bit
 - ¾ x 2" Template Bit - (Top Bearing)
- Various Decorative Router Bits for Edge Details
- Table Saw
- Coved Splash Kit
 - ¾" Cove Bit
 - 7/8 ~ 1" Straight Bit
 - Router Guide
 - Bar Clamp - 2 for every 6" of Back Splash
 - Daniclamps - 2 for every 6" of Back Splash
- Seaming Tools
 - Depending on the Method you choose
- Additional Tools
 - Depending on the need, more Router, Sanders, Panel Saw,
 - CNC machine, Shaper, V-Groove machine...

Router

Task	Minimum Power	Tool/Bit
Trim Router	N/A	Carbide tripped trim router bits
General purpose work : e.g. edge and seam trimming, cutouts	1 ½ Hp (1.1 kw)	12mm (½")carbide tripped single flute with 12mm (½") shank
Heavy duty work: e.g. bulk cutouts, banjo cuts, coving	3 Hp (2.3 kw)	10mm (¾")carbide tripped double flute with 12mm (½") shank
Revolution per minute (rpm) : 10,000 ~ 28,000		

[4.2 - A]

 **TIP**

The recommendations above are based on maximizing maintenance on routers and quality tungsten tipped bits in day-to-day operations

Saws

Blade diameter (mm/inch)	No. of teeth	Plate (mm/inch)	Task (mm/inch)
200/8	64	2.2/0.09	2.8/0.11
250/10	80	2.6/0.10	3.2/0.13
300/12	96	2.6/0.10	3.2/0.13
350/14	108	3.0/0.12	3.6/0.14
400/16	120	3.6/0.14	4.4/0.17
450/18	144	3.6/0.14	4.4/0.17
500/20	160	3.6/0.14	4.4/0.17

[4.2 - B]

Regardless of the type of saw, all saws must :

1. Be heavy duty
2. Have triple-chip blades of tungsten carbide
3. Have hook angle blades with pitch of -5 to 10 degrees and be described as "for cutting hard plastics"
4. Have 4,000 ~ 6,000 rpm
5. Have a quietblade, small gullets, brass plugs and heavier blade stock
6. Be used for cutting a straight line

Blades must be sharpened regularly with a 400 ~ 600 grit (20 ~ 40 micron) grinding wheel.

Blades must have 8 teeth per diameter inch (25mm diameter) and are recommended for Solid Surface.

5.1 Site Inspection

Before installing Staron®, it is very important to make sure all relevant site details are checked and verified.

Overview

1. Inspect the surroundings from parking lot to installation site.
 - accessibility from the parking lot to the front door
 - check for the distance and other obstacles
 - entrance size
 - wall condition
 - ceiling height
 - cabinet condition
 - electrical and plumbing positioning
 - make note of any other information which will help to minimize problems during fabrication and installation of Staron® Countertop
2. Relationship between you and your customer.
 - Code of Conduct
 - professionalism
 - detailed instructions on what they need to have completed before the installation date
 - inform consumers on what they should expect and what you will do to minimize the noise, dust, and other impacts

Provide friendly consumer service, treating all consumers with service oriented attitudes, courtesy, and respect at all time.

- On-time Scheduling.
 - Provide accurate scheduling.
 - Arrive on the day and time as promised.
 - In case of delay or cancellation, notify the consumer before the scheduled appointment.
- Provide professional image at all time, maintaining appropriate dress code.
- Do not smoke during service call.
- Do not be under the influence of drugs or alcohol during service call.
- Do not use drugs or alcohol during service call.
- Do not play radios or any other listening devices during service call.
- Do not take lunch break on service call premises.
- Do not use inappropriate language during service call.
- Keep the working area clean from beginning to the end, cleaning up all debris and dust during and after the installation.
 - Take all necessary precaution to protect the premises from dust and debris
- Please be sensitive to the consumer's concern.
 - Providing them the necessary information and explanation of the job.
 - All work should be discussed and agreed upon prior to the installation.
- Provide instructional materials and verbal instructions to the consumer on proper care and maintenance of the Staron® products.

5.2 Leveling

Prior to installing Staron® Countertops, make sure that all the cabinets are leveled.

Leveling and clearing all debris from the cabinets is very important in preventing future crack(s) to the Staron® Countertops.

Overview

Step 1 : Make sure cabinets are all on the same plane.

- Up to 1/8 " difference in the plane can be corrected by shimming the Cabinets straight.
- If there is more than an 1/8 " gap between the cabinets, they need to be reset.

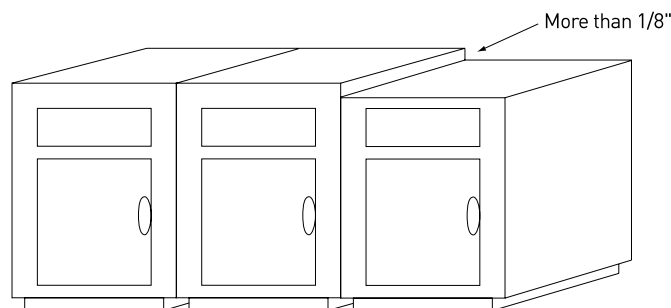

[5.2 - A]

TIP

Have the contractor or cabinet installer reset the cabinets. Remember, if something should happen while you are resetting the cabinets, you will be held responsible if any damage occurs.

Step 2 : Make sure all cabinet frames are clean and clear of all obstacles.

Old Cabinets - make sure all the old glue is completely cleaned from the top of the cabinets.

New Cabinets - Make sure all the staples, screws, brads and other obstacles are either pulled out or at least flush with the top of the cabinets.

Step 3 : All cabinets and end panels should be secured to the wall or the floor.

Make sure that no movement will occur. Any movement will cause stress in the Staron® Countertop.

TIP

Moving Blanket

Take some moving blankets to the Jobsite. Spread the blankets out from the entrance to the installation site. Make sure that your shoes or your tools don't touch the customers floor or cabinets. Your customers will appreciate your effort and you will gain their confidence and trust.

5.3 Required Tools

Having proper tools will save time and insure quality workmanship

- Level, 2', 4', and 6'
- Chisel
- Hammer
- Screwdriver
- Straight edge 6' ~ 8'

Introduction

Before any fabrication of Staron®, make accurate templates that are true representation of the top. This will help to insure problem free fit during installation.

Templating is a vital part of the fabrication process.

If your templates are perfect and top is fabricated according to the templates, the installation will be problem free.

There are many different ways of making the templates, it is up to you to choose the one that best suits your business.

1. Measurement Templates
2. Luann Strip Templates
3. Cardboard Templates
4. Digital Templates

6.1 Measurement Templates

This method is used most often by Fabricators.

However, this method takes the longest time.

You need to spend more time and take more accurate measurements to make sure the top fits with minimal fitting on the jobsite.

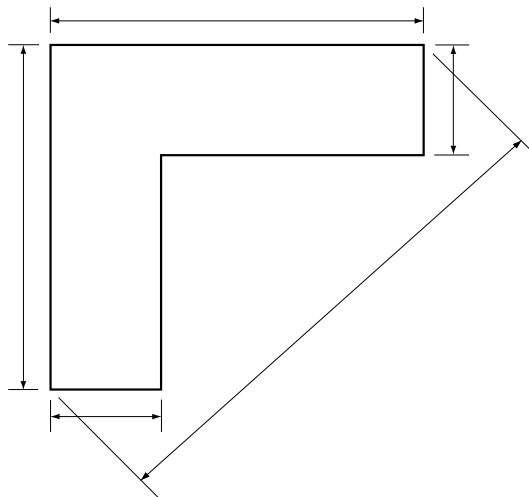

[6.1 - A]

6.2 Luann Strip Templates

$\frac{1}{8}$ " Luann is ripped to specific width depending on the overhang you desire.

Example :

- $1\frac{1}{4}$ " overhang
 - cut the strip to 2" wide
 - 2" strip = $1\frac{1}{4}$ " overhang + $\frac{3}{4}$ " cabinet frame
- $1\frac{1}{2}$ " overhang
 - cut the strip to $2\frac{1}{4}$ " wide
 - $2\frac{1}{4}$ " strip = $1\frac{1}{2}$ " overhang + $\frac{3}{4}$ " cabinet frame

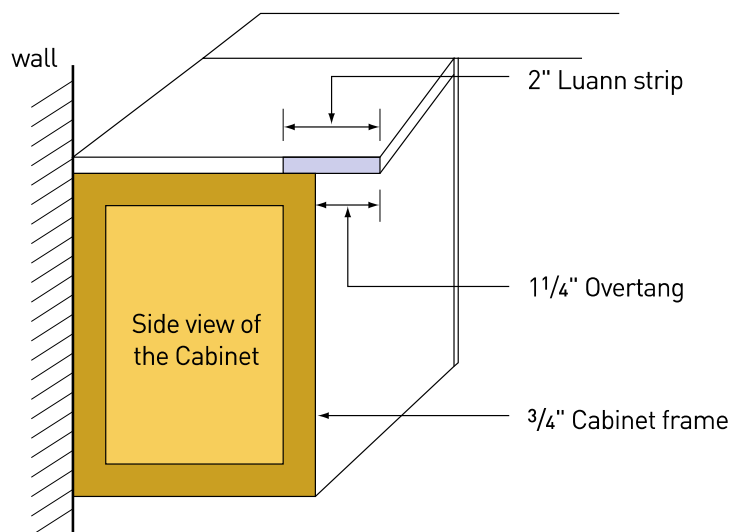

[6.2 - A]

Some people will make the template flush with the front of the cabinet and add the overhang later. As you create your templates, choose the method you are most comfortable with.

1. Make sure you have enough template material on hand.
2. Plug in your hot glue gun.
3. Start laying out your strips on the cabinets as illustrated in the drawing (6.2-B)

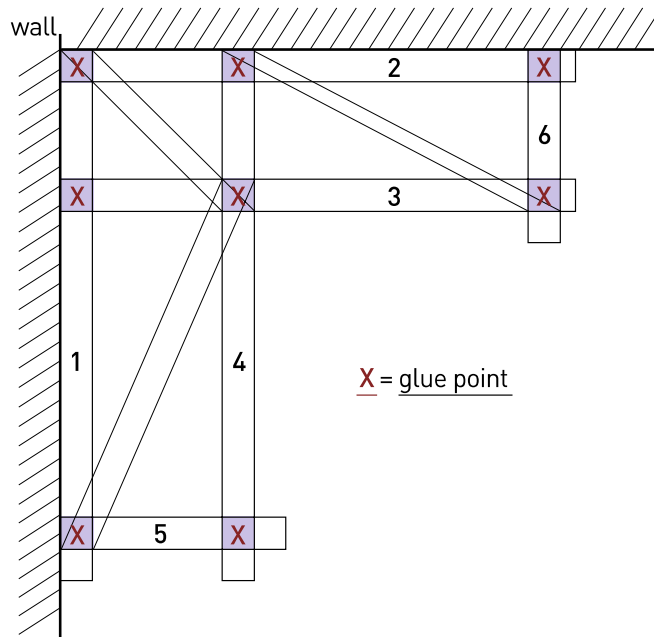

[6.2 - B]

Overview

- When the glue gun is hot, start gluing the wood pieces together.
- Do not bend the stick 1 and 2 tight to the wall, "let it float".
- Glue the sticks 3, 4, 5, and 6 tight against the wall.
- The sticks should be tight against the corner, where 1 and 2 meet.
- The points where 3, 4, 5, and 6 touch the wall will become your scribe points.
- Don't forget to mark the centers of your sink base on the templates.
- Mark the center of the cooktop or any other cutouts.
- Set sticks 3, 4, 5, and 6 flush with backside of the cabinet frame for exact overhang.

6.3 Cardboard Templates

Tips on why cardboard templates are good to use : (fits into small vehicle, use it as a cover, write customer info right on the template, doesn't fold easily.

Overview

1. Place the cardboard on the cabinets as illustrated in the drawing. (6.3-A)
Overlap the pieces (overlap by 8" - 10").
Hot glue the pieces together.

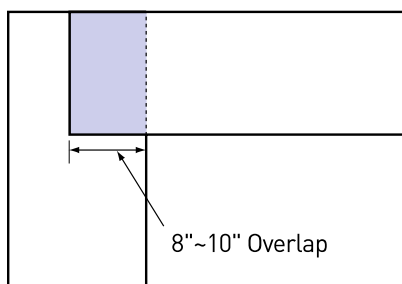

[6.3 - A]

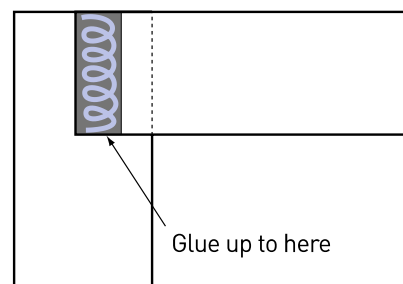

[6.3 - B]

2. When you get the cardboard to cover the cabinets, take your strips of cardboard (1½" wide strips) and glue them to form the frame as illustrated in the drawing (6.3-C)

These strips will give you exact measurements for scribing to the wall.

If you scribe the template to the walls, you can pre-scribe the top in the shop. Making the installation go faster.

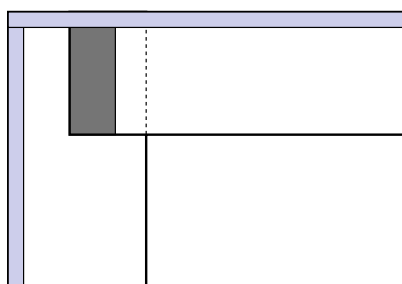

[6.3 - C]

- When the template is finished, trace the front edge of the cabinets to calculate and add the overhang.
Calculate the overhang you want and cut down to size.
Remember to mark all centerlines of the cutouts (sinks, cooktops, etc.).

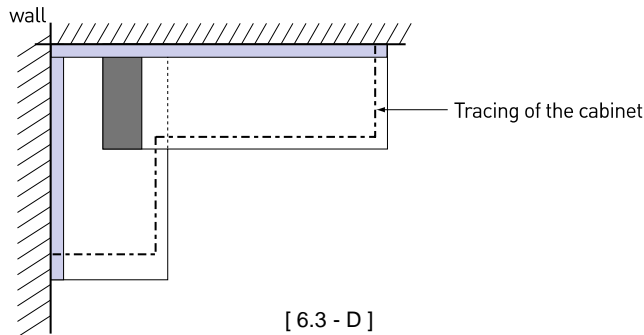

TIP
DO NOT FOLD THE CARDBOARD

Cardboard templates will show the customers the actual size of the top and give them the opportunity to change the size of the overhang or other features. Mark all the necessary information right on the template for easy access.
Cardboard templates can be used after the installation is completed to protect the countertop by taping it to the top. This will help protect against other trades such as painters, electrician, plumbers, etc from accidentally damaging the top. Remember, in many instances, you will be held responsible for the damage caused by other trades coming in after you. Protect your work by informing the customer and whatever barrier you can supply (cardboard template is a good start).

4. Cutting the template

In some instances, the template will be too big to fit in your vehicle.

Note
It is not recommended to cut templates, the integrity of the template structure will be voided.

The preferred method with card board templates. :

- If you have to cut apart the template to be able to fit it in your vehicle, cut it at one of your overlays (only through the top layer).
Illustrated in the drawing (6.3-E and 6.3-F)
- Afterwards, you can glue the template back together, where it will line up exactly.

TIP
DO NOT FOLD CARDBOARD!

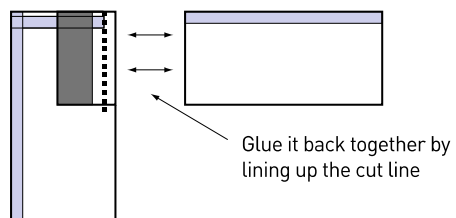
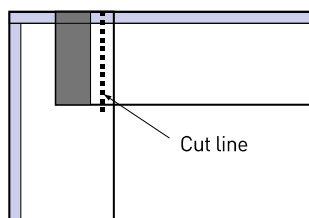

6.4 Digital Templates

With the advancement of technology, there are many different variety of equipments and programs to help with your templating needs. Please contact your Digital Template manufacturers for further information and instructions..

6.5 Tools Needed

- Hot glue gun
- Glue Stick
- Utility Knife
- Tape Measure
- Straight Edge
- Level 2', 4', 6'
- Paper and Pencil
- Magic Marker
- Template Material (depending on the templating method)
 - Luann
 - Cardboard
 - Digital Template Equipment

7.1 Planning

Careful planning is the key factor to a successful job.

When planning a job, having the right seam placement will help you minimize the use of material and time.

Remember, saving of material and time will help your business be competitive in the market.

In addition, the correct seam placement will help to insure that your customers to enjoy the beauty of Staron® Countertop without problems for years to come.

7.2 Positioning

All seams need to be at least 3" from sink cutout.

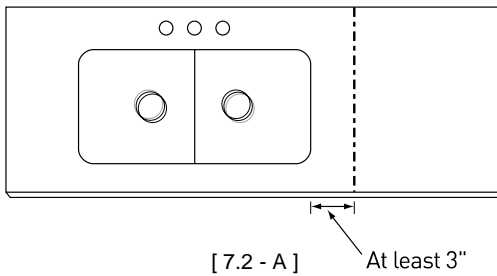

All seams need to be at least 3" from any cutout.

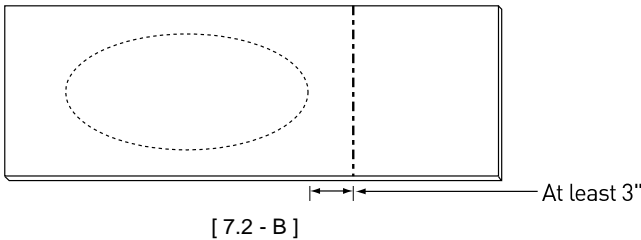

NO SEAMS THROUGH A COOKTOP!

Under no circumstances, should a seam go through a cooktop cutout.

If the kitchen is designed where there is no other choice, please contact Staron® Technical Service for advice.

All seams need to be at least 1" (25mm) past the radius of an inside corner. Seams are potential weak point where crack(s) can start. Seams that are located further away from the corner can better prevent crack(s).

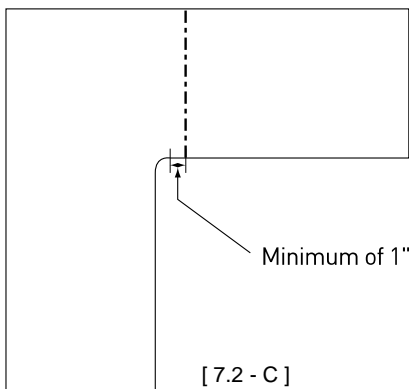

There should be no seams in an overhang on a peninsula or island.

Seams perpendicular to the overhang is allowed.

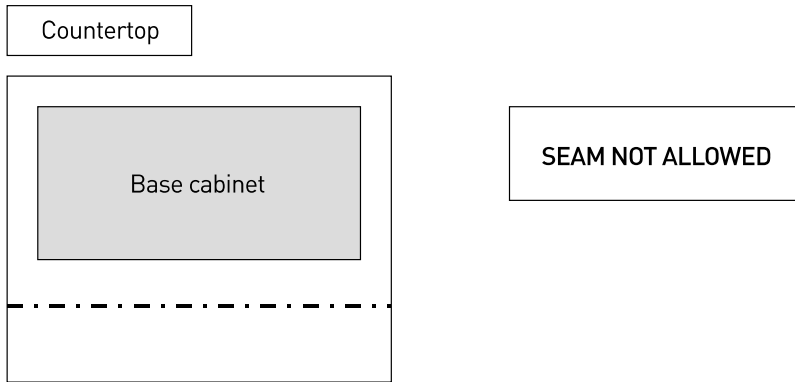

[7.2 - D]

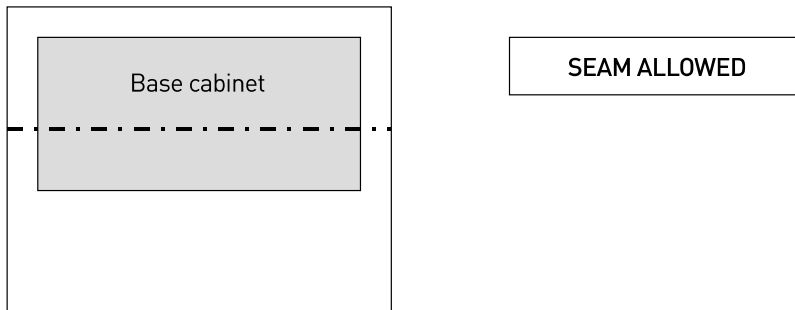

[7.2 - E]

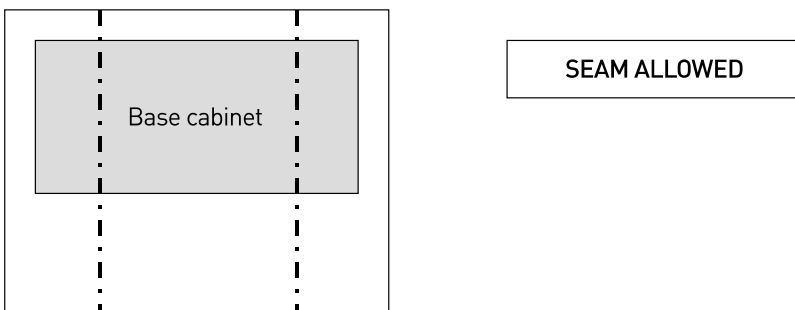

[7.2 - F]

On rare occasions, you will have a job seam going over a dishwasher.

You will need to support it from cabinet to cabinet with plywood.

Make sure to notch out plywood to accept seam plate.

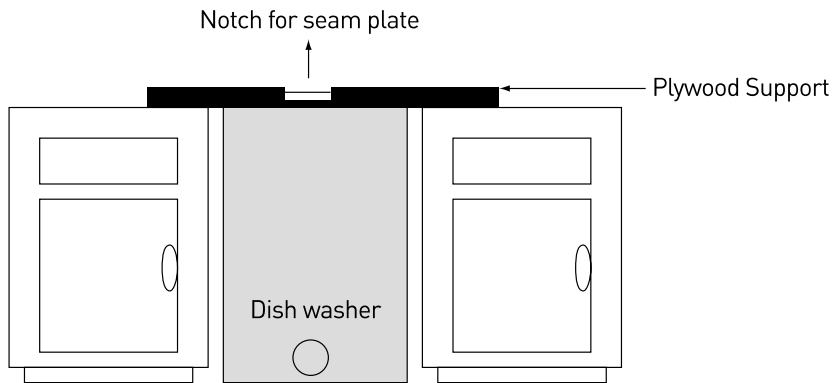

[7.2 - G]

Seams are not allowed through sink cutouts.

On rare occasions, there is no other choice but to seam on a splay corner with sinks.

Please consult with Staron® Technical Services before proceeding.

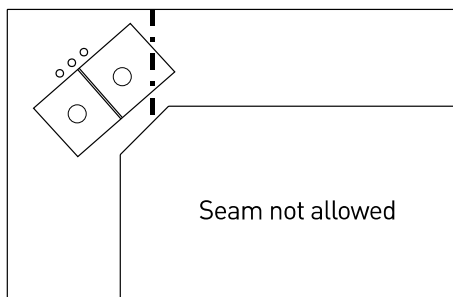

[7.2 - H]

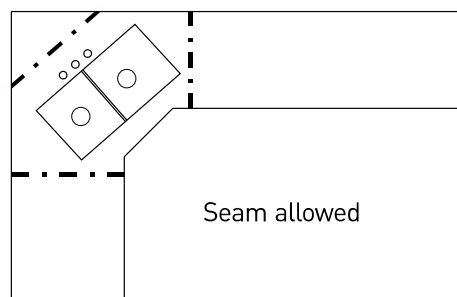

[7.2 - I]

8.1 Tools Needed

The following tools must NOT be used to cut Staron® at any time :

- Jig Saw
- Hacksaw
- Non Solid Surface Saw Blades
- Auger Bits

Recommended Tools

- Circular saw with Carbide or Diamond Blades
- Table Saw (with out-feed table)
 - 3 HP minimum
- Panel Saw
 - 5 HP (recommended)
 - Cabinet Saw or Stationary Saw (recommended)
- Routers (3HP minimum)
- Bar Clamps, "C" Clamps
- ½" Straight Bit (Carbide tipped)

8.2 Overview

When cutting Staron®, make sure the piece is totally supported.

When using a Circular saw, you will be rough cutting only. Always use a router and straight edge for final cuts.

Jigsaws should never be used to cut Staron® solid surface.

When using a router, always run the router left to right (clockwise).

All inside corners should have a minimum of ½" (13mm) radius.

Remember, the bigger the radius the better.

Radius larger than ½" should be done with a template.

➔ Note

All inside corners should have at least ½" radius. This includes all cutouts. Square corners will not be covered under warranty. Any 90 degree inside corner is a stress point, and will crack eventually.

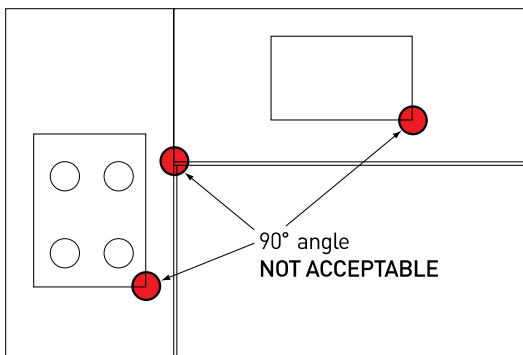

[8.2 - A]

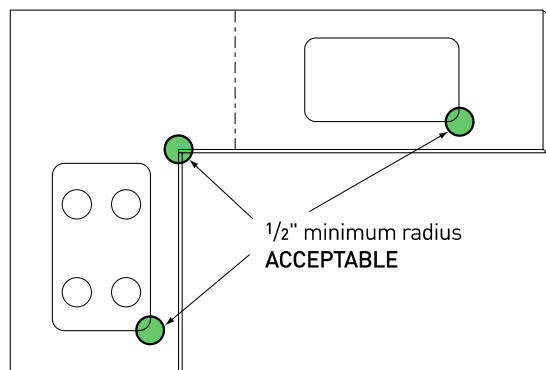

[8.2 - B]

9.1 Tools Needed

- Router : 3 1/4HP
- 1/2" x 1 1/2" double flute bit
- Straight edge
- Clamps
- Denatured alcohol
- Clean Rags
- Clamping Method
- Release paper or Scotch tape
- Ski router
- Sander
- Vacuum
- Sandpaper : 80 grit
- Panel Saw (Optional)
- Table Saw (For rough cuts)

Introduction

When planning any fabrication and installation of Staron®, seams should be planned in a manner which minimizes the use of materials and maximize product performance. Before putting seam adhesive between the two pieces to be seamed together, you need to machine the two pieces to match.

There are 3 ways to cut seams

- 1) Wavy edge bit
- 2) Straight cut using Panel Saw
- 3) Mirror cut

9.2 Wavy Edge Bit

1. This bit has a slight wave to it. It requires a special router base.

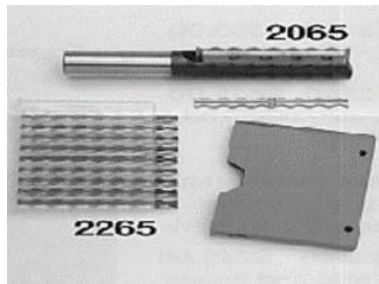

[9.2 - A]

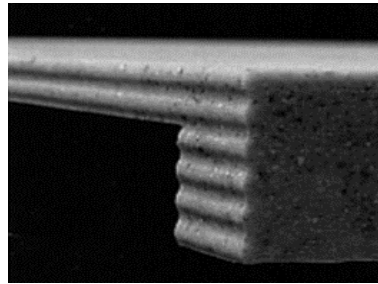

[9.2 - B]

2. Cut one piece with one side of the base.
3. Then, cut the other piece with the 2nd side of the base.
4. This offsets the "wave" of the router bit by 1/2".
5. Set up your straight edge back the amount of the router base.
6. Run the router from left to right.
7. By cutting your seams using this type of bit, you are allowing 50% more seam area.

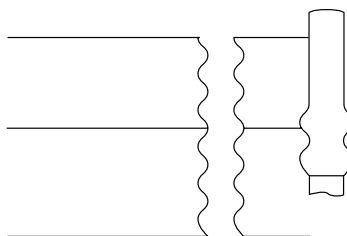

[9.2 - C]

9.3 Straight Cut

1. This method requires Panel Saw with Solid Surface Blade or CNC Router.
2. Remember, you should never use following tools as your final cut before seaming.
 - Table saw
 - Circular saw
 - Straight edge router
 - Or any other cutting method except Panel Saw, CNC Machine, or Wavy Edge.



[9.3 - A]



[9.3 - B]

9.4 Mirror Cut

1. Most effective method of getting a good seam when expensive machines such as Panel saw or CNC are not available, is to use a method called the "MIRROR CUT".
2. With this method, you will cut both pieces to be seamed at the same time.
3. This will make the two pieces match up perfectly "mirror" to each other.

Procedures:

1. Take the 2 pieces to be seamed together and set them $\frac{3}{8}$ " apart, making sure that the 2 pieces are parallel to each other.

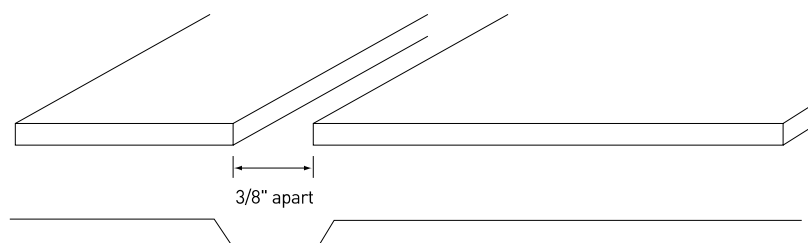

[9.4 - A]

➔ **Note**

You may want to make a "Jig" to make sure that the 2 pieces are exactly $\frac{3}{8}$ " apart throughout the seam line. This "Jig" could be made from a piece of Staron® or any other materials that will keep its form.

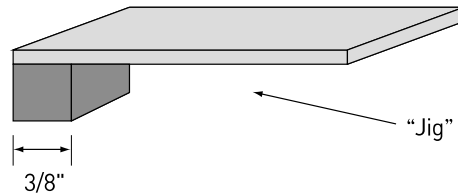

[9.4 - B]

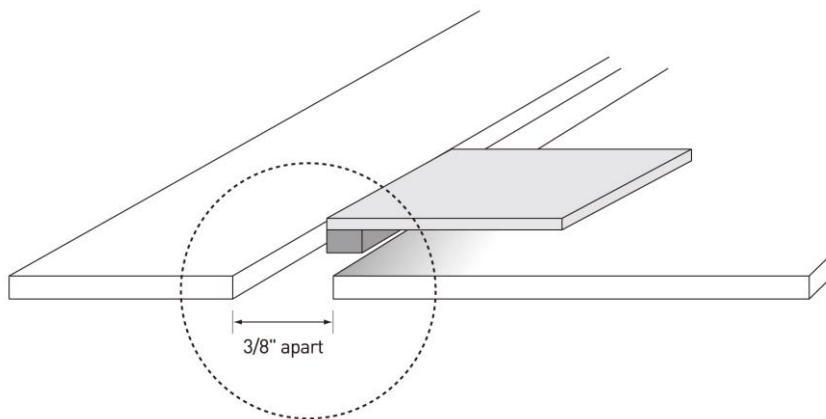

[9.4 - C]

2. After making sure that the 2 pieces are exactly $\frac{3}{8}$ " apart and parallel to each other, use a $\frac{1}{2}$ " bit and a router to cut.
3. Set up your straight edge on the left side of the 2 pieces being cut.
4. Measure the distance from the edge of the router bit to the edge of the router base + $\frac{1}{16}$ ".
5. Set the straight edge on the left side, back the same distance you just measured.
6. Set the depth of the router bit to go through the material.
7. Run the router from left to right.

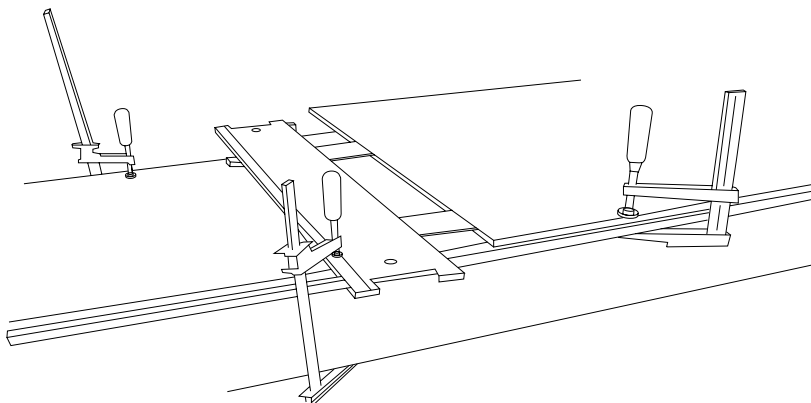

[9.4 - D]

SN-801-2016

TIP

Make sure the cord does not get caught on a clamp or table.

Once you start the cut, **DO NOT STOP!**

Make sure to clamp all the pieces so they do not move.

When using a Mirror Cut to cut your seam, make sure to have the 2 pieces **FLAT**.

If your pieces are not flat, the seam will open up, resulting in a bad (visible) seam.

If the 2 pieces are flat when cutting, your seam should turn out perfect.

The seam line should disappear if your cut is perfect when you dry-fit the 2 pieces.

Remember, if you see a seam line when you dry-fit the 2 pieces, you will see the line after you glue them. Re-Cut the pieces before proceeding.

Note

If the seam disappears without seam adhesive, then your seam will disappear with seam adhesive as well.

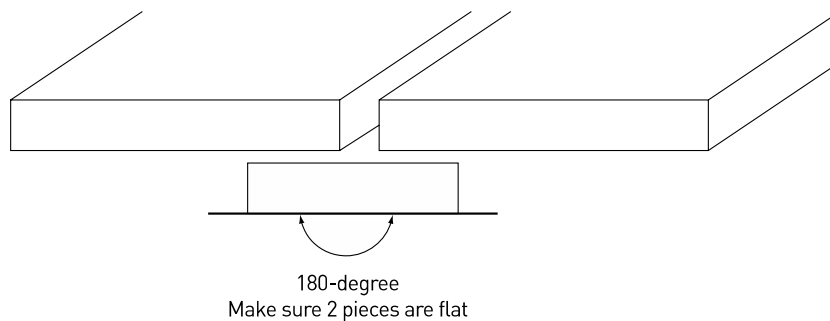

[9.4 - E]

9.5 Edge Preparation

After seams are cut, using one of the methods listed above, you will be ready to apply seam adhesive.

However, before applying seam adhesive, good edge preparations are necessary by removing and following procedures below.

Procedures :

- Abrade or sand the edge of the material, make sure not to round off the edge you just cut.
- You need to use 150 grit (100 micron) or equivalent sandpaper.
- All you need to do is to go over the edge 2 to 3 times.
- Abrade everything but the top 1/16". Abrading the whole edge will round the top you've just cut.

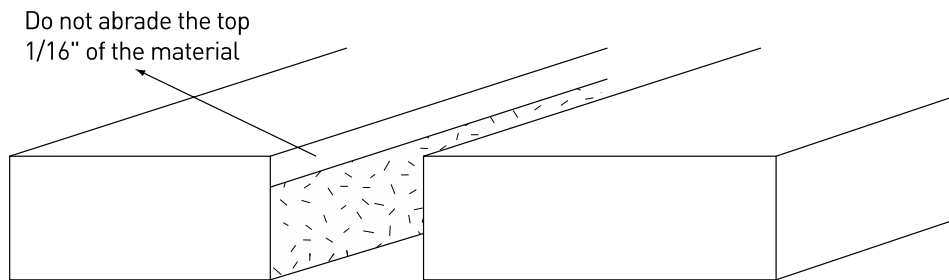

[9.5 - A]

TIP

Abrade by hand. You could round off the top edge with a sanding block.

If you round off the top edge, your seam will show when finished.

9.6 Seam Adhesive

1. After Seam preparation is completed, you are now ready to apply the adhesive.
2. Place some sort of release paper (red rosin or craft paper) under the seam.
Without a release paper under the seam, the seam adhesive will glue the top to the table.
3. Release paper can be anything from wax paper to Scotch Tape®.
4. 2" wide Scotch Tape® seems to be enough, however, it is advisable to place another layer side by side to just in case the top moves.

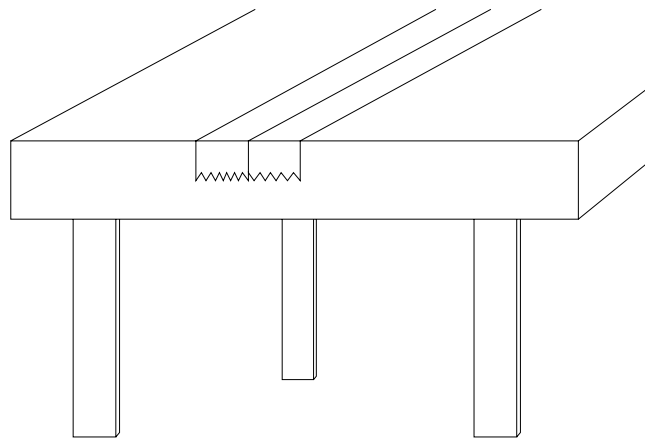

[9.6 - A]

5. Wipe the 2 seam pieces down with denatured alcohol.
6. Remember to wipe in one direction. This way, you will not contaminate the area you just wiped.
7. Remember, once you wipe the material down, do not touch the pieces.
The seam adhesive could pick up the oils from your skin and discolor the seam. This happens most commonly on the light color materials.
8. Decide what kind of clamping method you will use to clamp the two pieces to be seamed. There are several ways to clamp the pieces together.
 - A. Wood block and clamps
 - B. Suction cups and clamps
 - C. Paralign or similar clamping system



[9.6 - B]



[9.6 - C]



[9.6 - D]

9. Once you decide on a clamping method, the seam adhesive can be applied.
10. Pull the 2 seam pieces apart about $\frac{1}{8}$ ".



[9.6 - E]



[9.6 - F]



[9.6 - G]

➔ **Note**

The sheets need to be flat before seaming. The flatter the sheets are, the easier the sanding will be when the seam adhesive is fully cured. If the sheets are not flat, they will need to be shimmed up. Remember, this needs to be done before applying seam adhesive.

11. Before placing the mixing tip on the adhesive cartridge, make sure to purge (squeeze) a small amount of seam adhesive out, to ensure both Adhesive and Activator are dispensing properly. Place the mixing tip and tighten with (locking nut) and once again purge (squeeze) the trigger twice to make sure you have good mixing at the tip.
12. After the seam adhesive is ready, start at one end and fill the $\frac{1}{2}$ " gap. It should be about full. Do not leave any air holes or lapses in the adhesive. If there are any air holes or lapses, go over the entire seam again with second bead.



[9.6 - H]

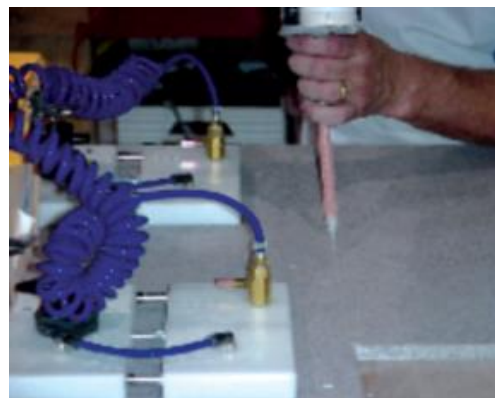

[9.6 - I]

➔ **Note**

It is easier to start at the furthest point of the seam and pull the seam adhesive toward you.

13. Once the seam adhesive is placed in the seam, the 2 pieces can be pulled together with whatever method of clamping you have chosen.
14. Let the seam adhesive dry until it is as hard as the sheets themselves.
This usually takes approximately 45-60 minutes, depending on the air temperature and sheet temperature. The seam will dry faster when it is warmer and take longer when the temperature is cooler.
15. The width of adhesive seaming line should not exceed 0.12mm



[9.6 - J]



[9.6 - K]



[9.6 - L]

➔ **Note**

Once the seam adhesive is fully cured, it can be sanded down.

The seam adhesive is cured when it is no longer wet. It should be hard to the touch.

Some of the seam adhesive will squeeze out when the sheets are pulled together. They could be easily removed using a Ski-Router or a sander. Do not apply too much pressure to the seam as this may squeeze all the adhesive out, thus weakening the seam.

9.7 Ski Routing and Sanding

Once the seam adhesive has fully cured, it can be taken down using a Ski router.

Ski routers can be purchased or made, using a router with ½" bit and a ski (piece of wood or Staron® material) attached to the base of the router.



[9.7 - A]



[9.7 - B]

1. Set the bit flush with the top.
2. Run the ski router over the cured seam adhesive and route off any excess seam material.
3. Once the excess seam material is routed off, you can finish up by sanding the area. Sand it with 150 grit (100 micron) sandpaper. Do not stay in one area too long while sanding. This will create a valley on the top. Remember to keep the sander moving at all time.
4. When the sanding is finished, an area of about 18"~ 20" should have been sanded, This will help feather out the seam area.

➔ **Note**

Never remove excess adhesive with a belt sander as this will overheat the seam causing possible weakness, discoloration or failure.

▶ **TIP**

Spray the seam area with water and look at the seam. It is at this point, you need to decide if the seam is acceptable or needs to be redone. If the seam needs to be redone, it is better to do it now, rather than after all the work is done. This will save you time and material in the long run.

9.8 Seam Plate

After the seams are sanded, seam plates need to be seamed on.
A seam plate is a 4" wide piece of Staron® material with 45° angle cut on both sides.

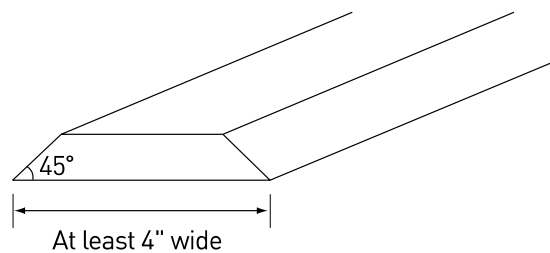

[9.8 - A]

➔ **Note**

Remember, 90 seam plate is a stress riser.
Seam plates should be cut to 45° angle.

When seaming on a seam plate, there are several steps that need to be taken.

1. Make sure the seam plate does not rock. Seam plate should sit flat on the top.
2. Cut the seam plate from the back of the front buildup to the rear of the top.
There shouldn't be any gap between the front edge buildup and the seam plate.
3. Abrade both the seam plate and the top where they will be glued together.
4. Center the seam plate over the seam. There should be 2" on both sides of the seam. Trace out the seam plate.
Clean with denatured alcohol.
5. Place the seam adhesive on the top where the seam plate was traced out.
Apply seam adhesive on all the perimeters and every $\frac{3}{4}$ " to fill in the traced out area.

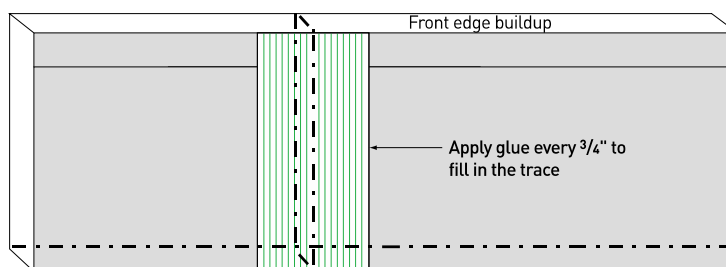

[9.8 - B]

TIP

This will give an adequate amount of seam adhesive to give 100% coverage.

6. Place the seam adhesive between the seam plate and the front edge buildup.
This will make the top, seam plate, and the front edge buildup become one piece.
7. Clamp the seam plate to the top. When the seam plate is clamped, the seam adhesive will spread to give 100% glue coverage.

Note

Seam adhesive should bead up along the outside edge of the seam plate.
Do not scrape off the excess. This adds strength to the plate and the top.

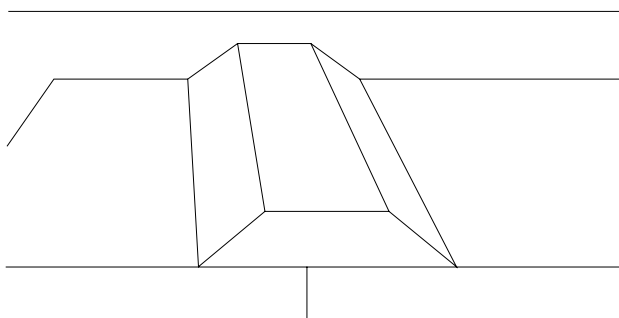

[9.8 - C]

In fabricating a Staron® Countertop, you have the option to give the customer a unique edge treatment, which will look great and make the people love their Staron® Countertops.

There are three effective ways to buildup the edges for Staron® Countertops.

- Stacked Edge
- Drop Edge
- V-Grooving

10.1 Stacked Edge

Stacked Edge Buildups

Stacked Edge buildup is a deck with 2 layers of ½" material stacked on top of each other. (Illustrated in 10.1-A)
With this method, in addition to building up the edges, decorative inlay stripes can be accomplished very easily.

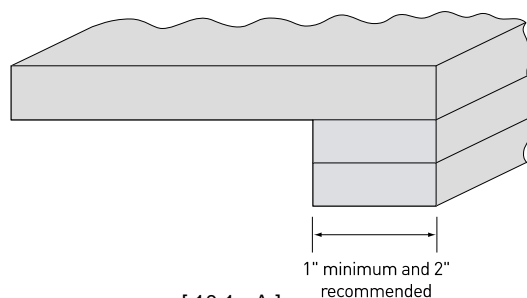

[10.1 - A]

When applying seam adhesive to the deck, place seam adhesive on back edge, front edge, middle where the stacked edge is being place.

Apply double ¼" bead of adhesive to the top of each other.

Place wood blocks every 12" behind the build up to keep the build up from sliding back once the adhesive is applied.

Hot glue these blocks down at 45° angle on the deck. This will make it easy to remove them later, when all the buildups are seamed on

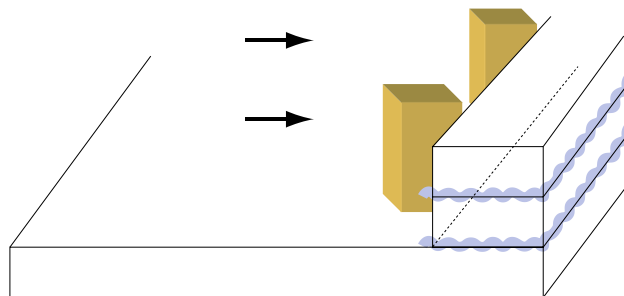

[10.1 - B]

TIP

With accent strips, use the color seam adhesive that matches the strip being put in the top.

Wood blocks can be made from any wood.

¾" MDF seems to be the best choice.

MDF is easy to remove when the buildups and other tasks are finished.

Clamp the edge buildup with 2" spring clamps or Dani clamps every 2" ~ 3".
This will give just enough clamping pressure to make the seams inconspicuous.

➔ **Note**

Too much clamping can cause all the seam adhesive to be squeezed out.
This is called "Starving the Seam". If you starve the seam, there is a good chance of seam failure during the life of the countertop due to lack of seam adhesive holding the materials together.

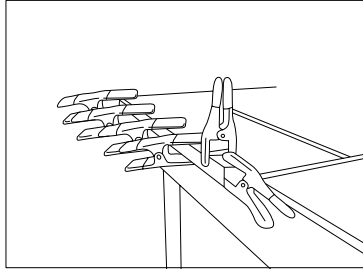

[10-1 - C]

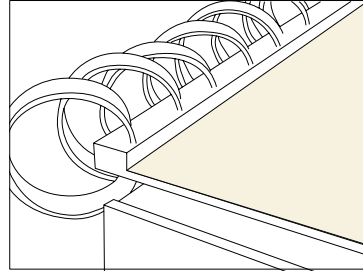

[10-1 - D]

Once all the Edge Buildups are seamed on and dried, route the front edge square to the top.
This can be accomplished by either setting up a straight edge and router with template guide or using a flush cutter

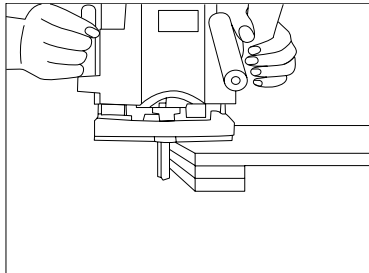

[10-1 - E]

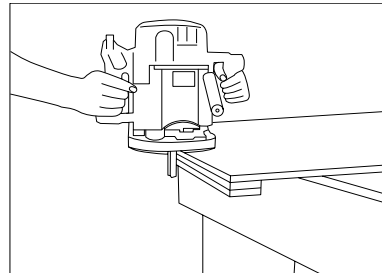

[10-1 - F]

Using Template Guide : To route flush with a straight edge, use router with 1" template guide and 1/2" bit.
Setup the straight edge 1/4" back from the front edge. Clamp in place and route.
Run the router from left to right. This will cut the entire thickness of the buildup flush and keep the front edge square to the top.
Make sure to line up the radius template with the edges already cut.
Repeat the process to cut all the straight sides.

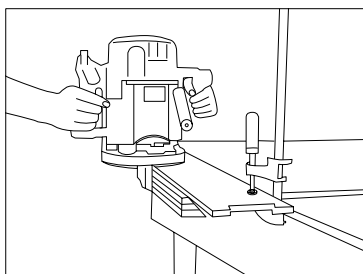

[10-1 - G]

▣ **TIP**

For easy fabrication, use the straight edge system that uses interlocking radius corners and straight lines.
With an interlocking straight edge system, misaligning the straight edge and the radius template could be avoided.

Similarly, with the interlocking system, you can use either the 1" template guide and ½" bit and follow the instruction on the previous page or use a flush cutter with the top bearing.

Using Top Bearing Flush Cutter : With a top bearing flush cutter, the straight edge does not have to be set back.

The Straight edge should be placed right on the line to be cut.

Unlike using a template guide, you are cutting right against the Straight edge.

Using the flush cutter will eliminate the chance of any measurement error in trying to set the straight edge back ¼" to compensate for the template guide.

If the line is traced right off the template, then cut on the line.

Clamp the straight edge down and route the excess material off.

➔ **Note**

Run the router from left to right when using a template.

Once the buildups are cut to size with the router, Decorative Edge can be routed to give the Staron® countertop the elegance and grace...

➔ **Note**

Turn to Decorative Edge Profile for further instructions. (10.5 page 47).

10.2a Drop Edge (Standard)

Drop Edge (Standard) Buildups

➔ **Note**

For the recommended edge buildups to Staron® product that has the larger particulates, such as Quarry, Talus and Breccia Series, please see 10.2b Drop Edge (Rabbit Method)..

With Drop Edge Buildups, the buildup strips are cut in 1" width and set on the countertop.

In addition, second piece of Staron® strips are required to be seamed up-against the front piece. This will allow the added strength it requires.

With this method, instead of 2 seams possibly showing in the front edge, there will be only 1 seam and it will minimize the chances of error.

Remember, if the seams are fabricated correctly, you should not worry about seams showing!!!

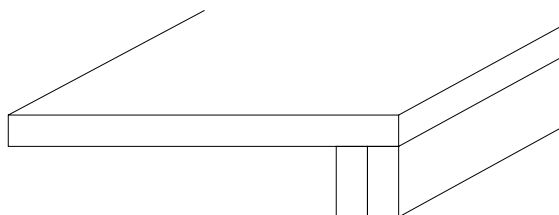

[10-2 - A]

When dry fitting all the buildup pieces, place the front pieces (#1) on first.

Temporarily clamp in place for the entire top.

When the front pieces (#1) are all finished, cut and place the back pieces (#2).

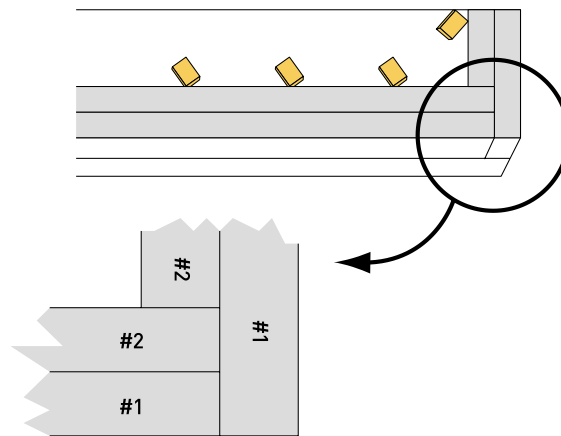

[10-2 - B]

Block the back with wood blocks every 12" with hot glue. This will help stop the build up from sliding all over the place when the seam adhesives are applied.

Mark the pieces to avoid mix-ups.

Prepare all pieces for seam adhesion by abrading with 150 grit (100 micron) sandpaper, wiping down with denatured alcohol.

Start applying seam adhesive in the corner and work out from there.

Place the seam adhesive where the piece #2 sets.

Seam all the #2 pieces first. When #2 pieces are seamed, apply the seam adhesive on the back area of #1 pieces.

By applying seam adhesive on the back of #1 pieces, this will seam the #1 and #2 pieces together = making them one.

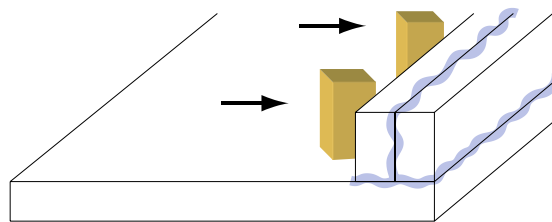

[10-2 - C]

Similar to the Stacked Edges, when the seam adhesives are fully cured, route off excess material and glue from the edge buildup. Refer to section 10.1 for instruction.

TIP

When using Drop Edge buildup method, different color inlay strip cannot be added during the buildup process.

10.2b Drop Edge (Rabbit Method)

Drop Edge into rabbet is recommended for fabricating Staron® product that has larger particulates, such as Quarry, Talus and Breccia series. While basic fabrication remains the same as other Staron® color families, the larger particulates that define the unique patterns in the Quarry, Talus and Breccia require modification to the method which is used to create an edge minimizes visible seams at the edge build-up.

On your first Quarry / Talus / Breccia project we suggest you experiment, prior to final fabrication, the drop edge with rabbet described next.

Route a rabbet at least 3/16" deep at the bottom side of front deck edge.

Cut the strips to desired height/width.

The larger and front-facing strip is then adhered to the 3/16" rabbet on the leading edge of the deck (10.2b-A).

Back with a second strip of Staron® to add strength and support.

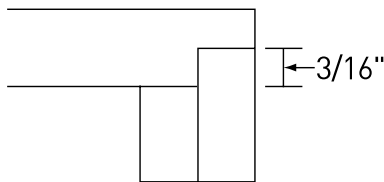

[10.2b - A]

10.3 V-Grooving Buildups

V-Grooving is an easy way to do a drop edge.

We will briefly discuss this type of edge treatment. However, for more details, contact your V-grooving Machine manufacturers.

With V-grooving system, "V" is routed into the Staron® top.

Seam adhesive is placed in the "V" and folded up.

Very few clamps are needed to clamp it closed.

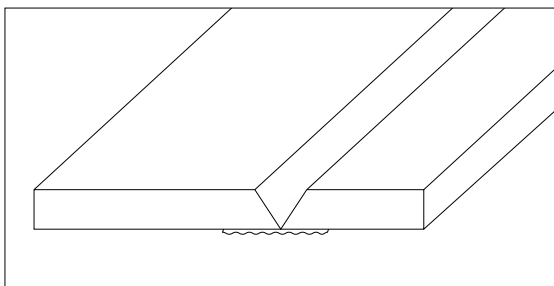

[10.3 - A]

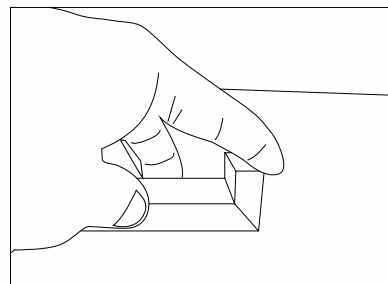

[10.3 - B]

Remember that you should prepare the seaming area by wiping out the "V" with denatured alcohol.
When the seam adhesive is fully cured, pull the tape off the front.
There is no additional routing of the edge like in the stacked or dropped edge buildups.
The decorative edge can be routed right away.

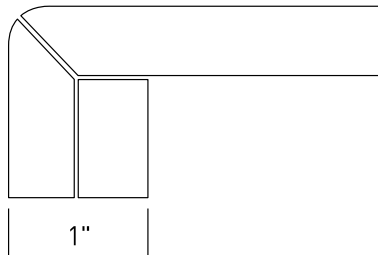

[10.3 - C]

 **TIP**

This method will save fabrication time, however, you will have to purchase very expensive machinery. Similar to drop edge, different color inlay strip cannot be added during the buildup process. It is strongly recommended that a second piece be seamed behind the front piece for added strength. (10.3-C) All inside corner must have a minimum of ½" (13mm) radius, but the bigger the radius the better. Also use a block of Staron® at least 6"x 6" in inside corner.

10.4 Inside Corner Buildup

With every Staron® Countertop built with inside corners, it is very important to take precaution in building the inside corner buildups properly to prevent any future cracks from occurring. In order to provide added strength, the inside corner buildups need to be over lapped.

- Stacked Edge Buildups
 - Stack two 4"x 6" block pieces in the corner.
- Drop Edge Buildups
 - Stack two 6"x 6" block pieces in the corner.
- V-Grooving Buildups
 - Refer to V-Grooving Machine manufacturer for details.

Stacked Edge : The two 4"x 6" block pieces need to be going in opposite directions. This way, all the seams in the edge buildup will have seam plates built in.

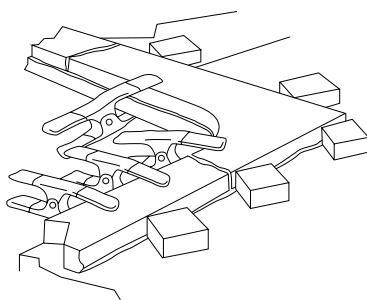

[10.4 - A]

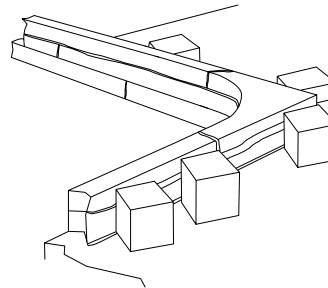

[10.4 - B]

Drop Edge : Use the two 6" x 6" block pieces to seam the inside corners together.

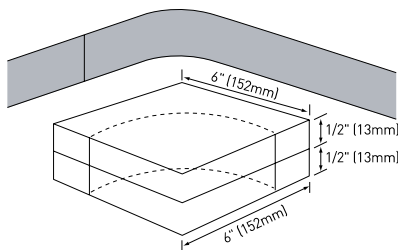

[10.4 - C]

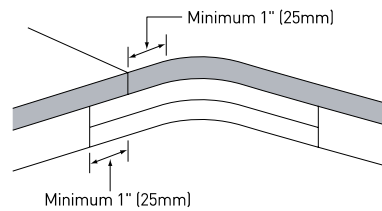

[10.4 - D]

End of 6" x 6" corner block must be overlapped a minimum of 1" (25mm) or more past from deck seam.

➔ **Note**

Deck seam in buildup edge must be a minimum of 1" (25mm) past the radius in the inside corner, but further located seam from the inside corner can better prevent crack(s).

All inside corner must have a minimum of 1/2" (13mm) radius, but the bigger the radius the better.)

When inside corner buildup blocks are ready, seam all the buildups at the same time. 100% glue coverage is required. Remember, with drop edge inside corner buildup, make sure all the pieces line up in the back. There shouldn't be any notch or set backs in the buildups. The notch will act as stress riser.

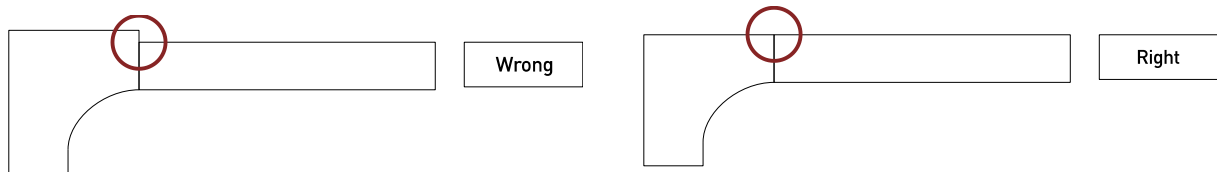

[10.4 - E]

▶ **TIP**

The smoother the edge, the easier it will be to finish the decorative edge profile.

Remember, if the front edge is left rough, the bearing on the decorative edge bit will follow the roughness, which will transfer into the decorative profile. This will take a lot of hand sanding to finish.

10.5 Decorative Edge Profile

Decorative Edges can be added to Staron® Countertop to add beauty and style. Remember, most of the countertops have Decorative Edge Profile. Amongst the following are the most commonly used.

- 1/4", 1/2", 3/4" Radius
- Bull Nose
- Champher
- Ogee

Because particulate distribution is heaviest on the top surface, quarter or half round edge routing is recommended for Staron® product that has the larger particulates, such as Quarry, Talus and Breccia series, to minimize the chance of an inconsistent appearance after the edge is completely routed.

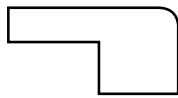

1/4" Corner Round



1/2" Corner Round

1/2" Corner Round
Top and Bottom

TIP

These are often routed both top and bottom of the top. Comprehensive Edge details are listed on the following pages.

Note

There are many different tool manufacturers developing bits for different edge profiling, please consult with the bit manufacturers for details on technical and warranty issues.

LOTTE ADVANCED MATERIALS Staron® will not be responsible for edge failures due to defective bit, flawed design of the edge, and other related circumstances.

When all the edge buildups are seamed on, cured, routed flush, and square to the top, the decorative edge can be routed on to the top. Mark the place to be profiled and always route from left to right.

When finished routing, the edge needs to be sanded.

Sand the decorative route and the front edge to the desire finish.

TIP

See finishing and polishing section for more details. (18.1 page 87)

Note

Always run the router on a scrap piece of material to check that the router bit is set to the correct depth.

When working with decorative edges that are very extensive, make sure you have enough buildup material and that there are no air holes in the middle of the buildup. They will show when you cut on that spot.

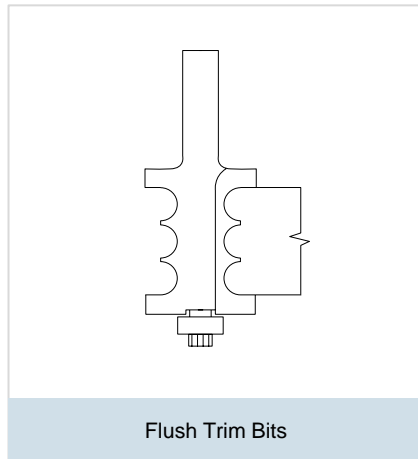

(Olympia)

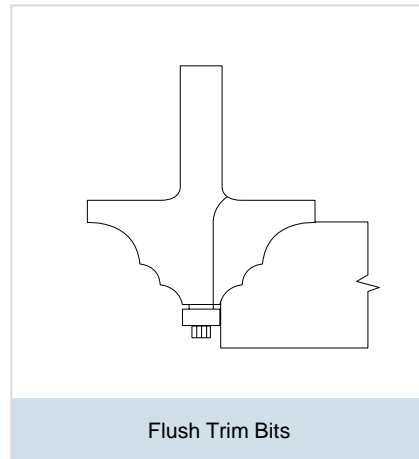

(Hillside)

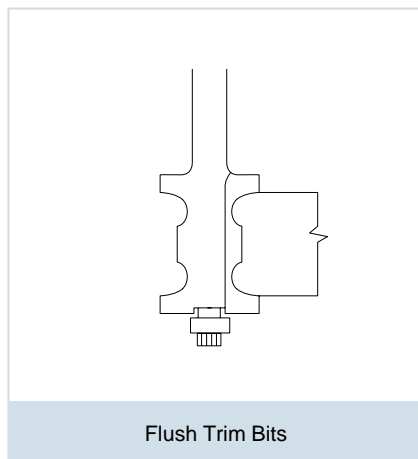

(Oakdale)

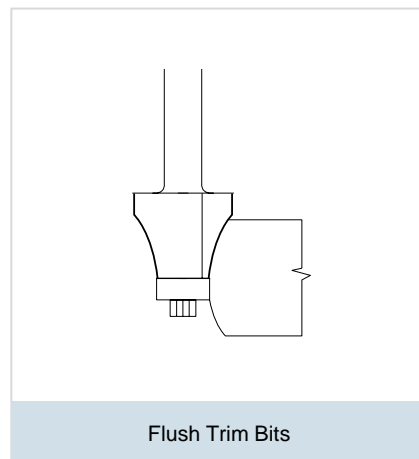

(N.Ocean)

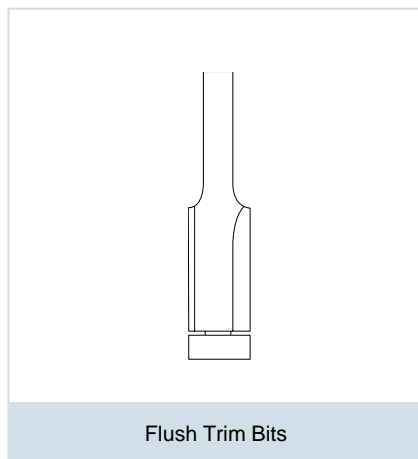

11.1 Overview

Inlays can give added beauty and decorative features to Staron® Countertops.

Inlays could range from decorative stripes in the Edge Buildups, signage, drawing, inscription, and many more for commercial and advanced decorative applications.

There are two categories in fabrication inlays.

- Hard Inlays

Pieces of Staron® are set into a routed slot and seamed together to form stripes and other decorative features.

- Poured Inlays

Liquid resins, ATH (Aluminum Tri-Hydroxide) and pigments are mixed to make the desired colors. These are then poured into routed slots.

11.2 Hard Inlays

Creating a slot in the counter:

Rout a slot with a straight bit.

This slot shouldn't be more than 3/16" deep.

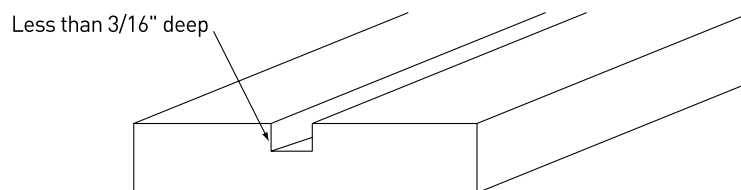

[11.2 - A]

Creating the insert piece:

The inlay insert piece should be cut on a slight angle of 1° to 2°.

Make the inlay insert piece 1/16" thicker than the depth of the slot.

This will allow the seam adhesive to work its way out and fill all the edges of the inlay.

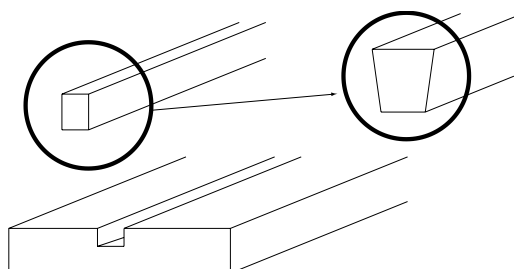

[11.2 - B]

Dry fit all the pieces first to be sure everything fits the way it is desired.
Abrade all pieces and slot with 150 grit (100 micron) sandpaper.
Wipe out the slot and the insert pieces with denatured alcohol.
After the alcohol is dried, place the seam adhesive in the corners of the slot.
Place the insert pieces into the slots and rock back and forth to help spread the seam adhesive.
Clamp the insert pieces in place. This will also help spread the seam.



[11.2 - C]

Ski-rout or sand the excess insert material and cured seam adhesive off.
Sand out with 150 grit (100 micron) sandpaper until smooth.

TIP

Remember to always feather out when sanding.
Check for air holes in the seam. Small gaps or air holes can be repaired by mixing some seam adhesive and fill.
Let it cure completely before sanding.
For curved inlays, the insert materials can be thermoformed to fit the desired design. (Refer to Chapter 22 for further Thermoforming instruction)



[11.2 - D]

11.3 Poured Inlays

Poured Inlays are usually used for difficult stripes and other decorative designs which requires more than straight strips. With poured inlays, you are limited only by your imagination.

Poured Inlays(Creating Slot)

On all inlays, do not rout out more than 3/16" to create the slot.
Using your hot glue, create a dam around the slot.
This dam will allow for overfilling of "Inlay Kit" to compensate for shrinkage.

TIP

Always overfill the slot with Inlay Kit, This will let the air bubbles rise to the top and compensate for shrinkage of the inlay kit.

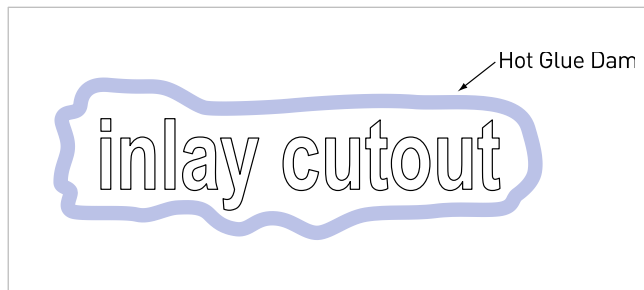

[11.3 - A]

Poured Inlays (Finishing)

Allow the inlay kit to fully cure
The curing process can take anywhere from 1 hour to 24 hours depending on the amount of catalyst in the inlay kit.
The curing times are effected by air temperature and humidity as well.
(Most Inlay Kits come with instructions)
When the inlay kit is fully cured, sand the inlay with 80-grit sandpaper to make it even with the countertop.
Finish the top as before (Refer to Chapter 18)

TIP

If the inlay kit is not fully cured before sanding, the inlay will shrink.
If too much catalyst is added to speed up the process, it will cause the inlay to crack due to the heat it creates.
Remember, it is very important to allow enough time for the inlay to fully cure.
To accomplish intricate designs where more than one color are needed, repeat the steps to create layers.
With CNC Machine, you will be able to accomplish multiple layers without sanding.

For a setback to a cutout,

- 1 ½" minimum from the back
- 3 ½" minimum from the front (undermount)
- 2 ¼" minimum from the front (drop-in)

12.1 Tools Needed

Recommended Tools

- 3HP Router
- ½" double fluted carbide router bit
- Templates
- 1" template guide for router
- Clamps

12.2 Making Cutout Templates

Sink & Bowl cutout Templates are an important part of fabricating Staron® tops.

Sink & Bowl cutout Templates will save you time and materials.

It is recommended to have templates of all the Staron® Sinks and Bowls for faster and accurate cutouts.

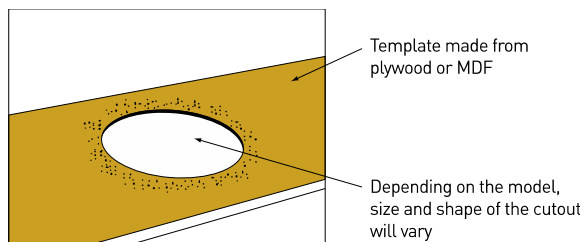

[12.2 - A]

Overview

1. You will need to make a wooden template of the sink to be cutout.
2. Trace the inside of the sink with a pencil.
3. Cutout the pencil mark of the template with a jig saw and sand to the line.
4. When you set the template on the sink, it should be flush to the inside of the sink.
5. If you cannot trace the inside of the sink, trace the outside and add the lip of the sink.

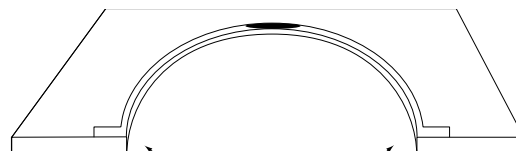

The Template and the inside of the Sink or Bowl should be flush.

[12.2 - B]

TIP

Always mark your template with a centerline and the model number of the shape
Mark what size of bit and template guide to be used.

12.3 Making Cutouts Using Templates

Overview

1. Always use a router for all cutouts.
2. **NEVER USE A JIG SAW ON CUTOUTS !**
3. Use a 1/2" bit with a 1" template guide for cutting out your sinkholes.
4. Remember, cutout should be 1/4" smaller than the sink itself.

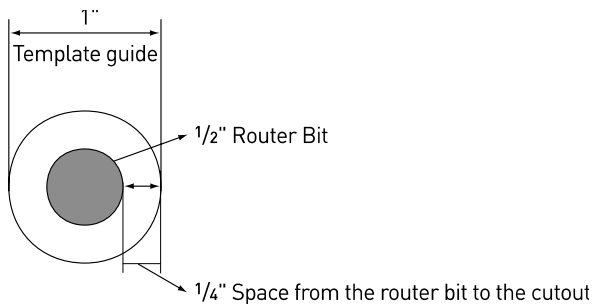

[12.3 - A]

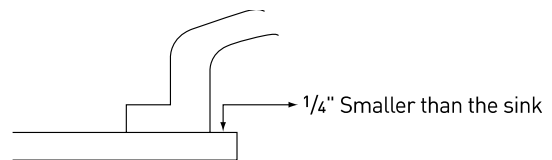

[12.3 - B]

TIP

Another way is to make the template 1/4" smaller. Use a top bearing flush cutter. Remember, both methods will give same results.

12.4 Making Cutouts Freehand

Overview

1. Sink & Bowl cutouts could be done freehand.
2. Remember, this method is not recommended.
3. Trace the sink on your piece of Staron®.
4. Add 1/4" to the inside of the sink.
5. Route freehand along the marking.
6. When routing, always run the router clockwise for smoother cut.

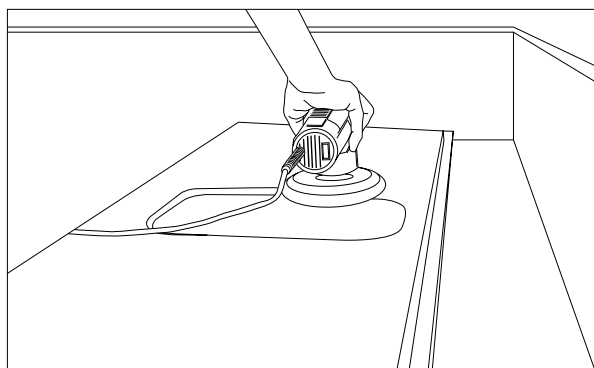

Note

This method is not recommended unless you have years of experience using routers. There is a greater chance of ruining the material and possibility of getting hurt. It is recommended that templates are used whenever possible.

13.1 Cooktop Templates

Overview

1. When cutting out Cooktops, always use a router.
2. You can make a template for each cooktop cutout or you can use pieces of MDF (3" wide) as illustrated in (13.1-A)
3. Remember, unlike sinks & bowls, there are too many different sizes of cooktops for making permanent templates.
4. Draw out the cooktop cutout on the top
5. Remember to center the cutout front to back.
6. Take your 3" pieces of MDF and hot glue them to your lines.
7. Put hot glue approximately every 8" (dime size amount will be enough).

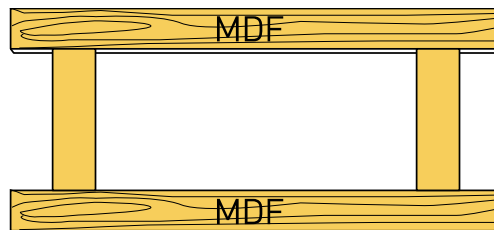

[13.1 - A]

TIP

Make sure all corners are at a 90 degree

13.2 Cooktop Cutout

Overview

1. Take $\frac{3}{4}$ " top bearing flush cutter with the bearing $\frac{1}{2}$ way down the MDF.
2. Plunge the bit into and through the material.
3. Run your router clockwise (slowly).
4. When you are finished cutting out the top, spray the wood pieces with denatured alcohol and let it soak.
5. This will help to release the hot glue.
6. Pry the pieces up with a chisel.
7. Use caution, do not chip or scratch the material.
8. Scrape off the rest of the glue with the chisel.

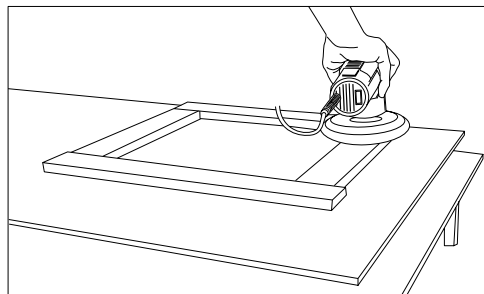

[13.2 - A]

13.3 High Strength Support

Overview

1. Put high strength blocks in the corner of the cooktop cutout.
2. These blocks need to be 4" by 4" or larger.
3. They also need to be cut at a 45° angle on all sides except where the piece may touch the buildup.
4. Leave the seam block square, where it touches the buildup.

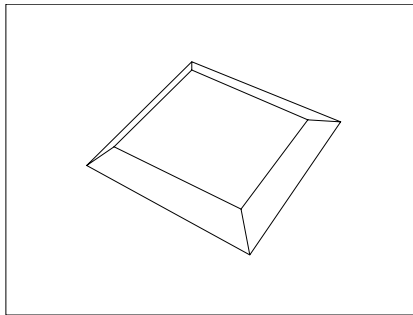

[13.3 - A]

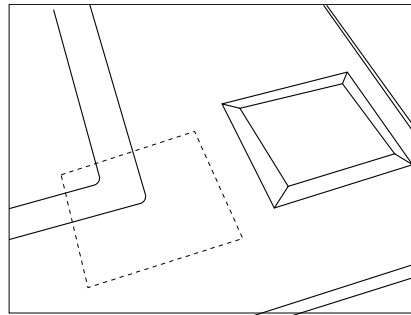

[13.3 - B]

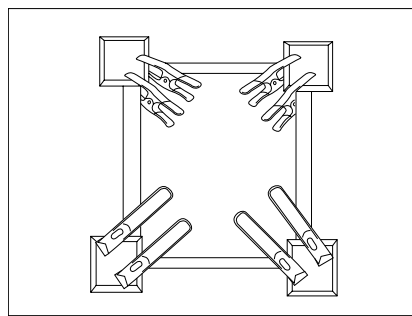

[13.3 - C]

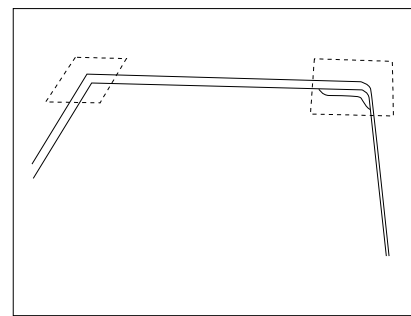

[13.3 - D]

5. When lining up the seam blocks, you need to flip over the top.
6. Center the blocks at the corner.
7. Trace the outside of the block with a pencil or scribe.
8. Seam the pieces to the top using seam adhesive.
9. There must be 100% glue coverage on the Seam blocks.
10. When the seam kit is dry, you will need to cut off the extra material with a router.

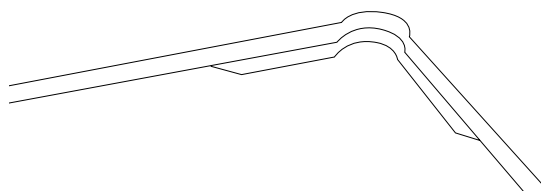

[13.3 - E]

Final Route (Corners of cooktop cutout)

13.4 Final Route

Overview

1. Next, you need to round off the corners.
2. To do this, you will need to raise the bit so the bearing is not below the base of the router.
3. Move the router into the corner (router off).
4. After lining up the router, turn the router on and run the router into the corner at a 45° angle until the bit touches the corner where the two lines meet (prior pencil mark when tracing the cooktop).
Use Router Bit $\frac{3}{4}$ " or bigger.
5. Repeat this step at all 4 corners.

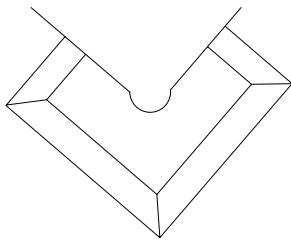

[13.4 - A]

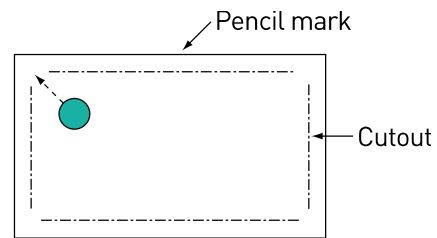

[13.4 - B]

13.5 Sanding

Overview

1. When you get all the corners cut out, you will have to sand the entire cutout with 150 grit (80 or 60 micron) sandpaper.
2. Rout a $\frac{1}{8}$ " radius on the top edge of the cutout.
3. Sand this until smooth.
4. Sand the bottom edge with a sander or by hand.
5. You need to get all the chips and router chatter out.
6. Remember, both the top and the bottom have to be sanded smooth to prevent cracks.
7. The smoother you get the cutouts, the better the end result.
8. Finally, you need to put Heat-Conductive Aluminum Tape
(One layer of 4 mils, at least 2" wide, ex: 3M 425 Aluminum Foil Tapes or similar) around the cutout.
[Please refer to the "Installation" Chapter 19]

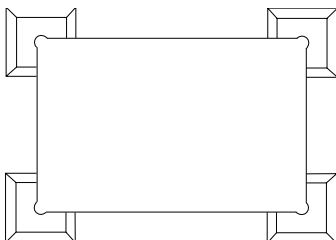

[13.5 - A]

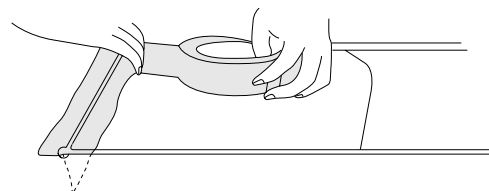

[13.5 - B]

13.6 Potential Problems

Overview

The cooktop area is the area where most failures can occur.
The following is the list of possible causes.

1. Heat - expansion and contraction (excessive heat).
2. Stress points in the cutout.
3. Missing protective heat tape.
4. Faulty cooktop, dispensing too much heat.
5. Not enough space between the cooktop and the countertop.
6. Missing high strength corner or seam blocks.

13.7 Prevention

Overview

Preventive measures.

1. Always use router for the cutouts.
2. Make the cutout as big as possible.
Example: If the cooktop manufacturer suggest the cut out to be 26"~28" by 18"~20"; the cutout should be at 28" x 20".
3. Minimum of 4"x4"x½ cooktop blocks with 100% glue coverage.
4. ¼" radius on the top edge of the cutout.
5. "Sand! Sand! Sand!" both top and bottom of the cutout.
6. Use 150 grit (80 or 60 micron) sandpaper on entire cutout.
7. Properly install protective heat tape (Refer to Chapter 19 on Installation)
8. Educate the customer on heat tape and it's proper use.

14.1 Countertop Support

Overview

1. All tops need to be supported every 12".
2. A normal countertop can be supported with wood strips (15/16" x 1 1/4").
3. Glue these strips on the Staron® top with 100% clear silicone and hot glue round the perimeter and down the middle.
4. If the Staron® buildup is 2" wide, you don't need to place wood buildup in the front.
5. It should be on the back and middle only.

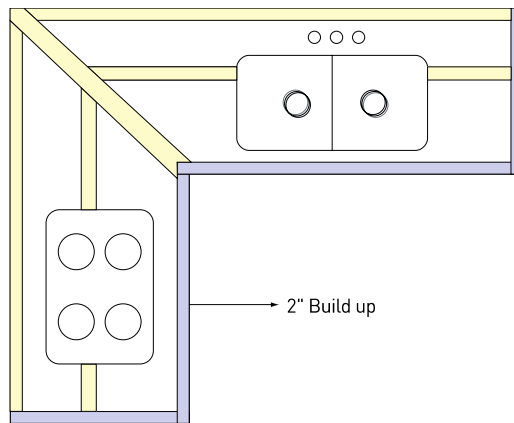

[14.1 - A]

Overview

If the Staron® buildup is 1 1/2" or less, you need to put wood support behind the Staron® buildup as well. Remember to leave 1/8" gap between the buildup and support.

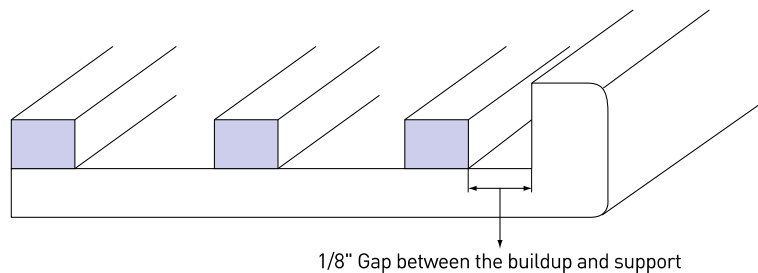

[14.1 - B]

TIP

100% sub-tops are not allowed.

Remember, you need to have air flow on both sides of the sheet to allow for expansion and contraction.

In some cases, you will need to cut out the cabinet covers.

Framing

Another method of giving support is framing

1. Common technique

Create a perimeter frame in the workshop. Glue the worktop onto the perimeter with silicone. Adjust the worktop to a perfect level when installing.

2. Special technique

Position a perimeter frame on-site and place the worktop over the frame for exact adjustment and leveling with the minimum of adhesion to allow for maximum movement.

The following materials are recommended for a perimeter frame.

- 25mm (1") moisture resistant M.D.F. board.
- 25mm (1") moisture resistant particle board.
- 25mm (1") moisture resistant plywood.

Remember, DO NOT use full underlayment because it can cause heat accumulation and thermal expansion, because Staron® and the wood frames are different materials, heat accumulation and thermal expansion could cause warping or cracking.

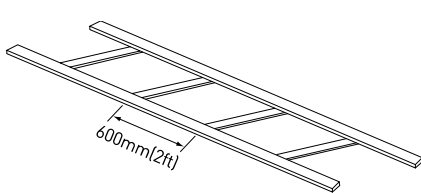

Constructed ladder system

[14.1 - C]

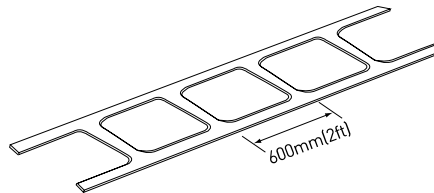

Routed ladder system

[14.1 - D]

14.2 Overhang Support

6" or Less

Overhangs of 6" or less do not need to be supported.

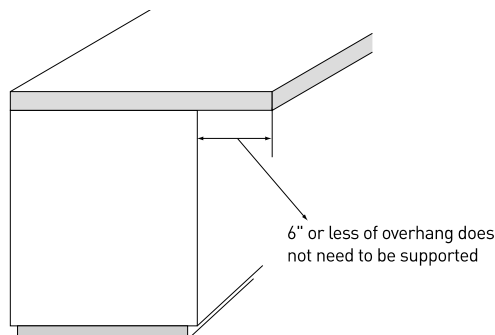

[14.2 - A]

TIP

It is recommended to put a piece of wood under this type of overhang to fill in the void. The customers will appreciate the professionalism.

7" ~ 15" Overhang

1. Overhang of 7" ~ 15" need to be supported with plywood, metal frame or Corbels.
2. For full plywood under mount, screw the support to the Cabinet from top. (Use 3" coarse threaded screws)
3. Afterward, silicon the top to the plywood.

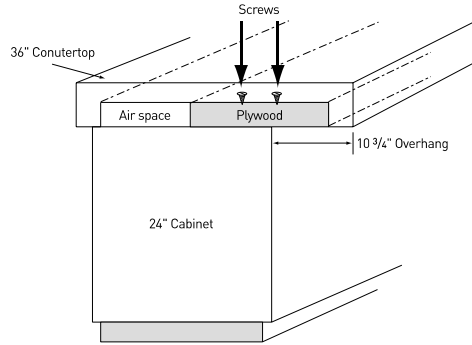

[14.2 - B]

TIP

This is not considered to be 100% sub-top, because there will be 10 1/2" airspace on the back of the cabinet.

4. With metal frame, you can give it entire coverage, because it is very similar to a "Ladder Support" described in Section (14.1-C and 14.1-D). You will have air on both sides.

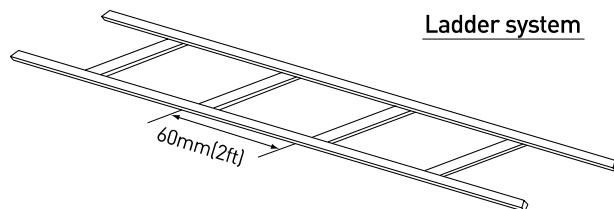

[14.2 - C]

5. Corbels

Usually made out of wood to match the cabinets, they can be made from Staron[®] materials to match the Staron[®] top. Corbels need to be 50% longer than the width.

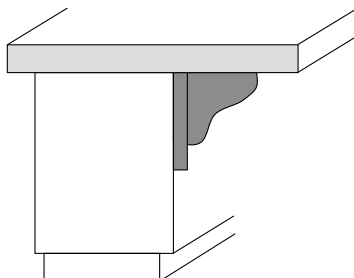

[14.2 - D]

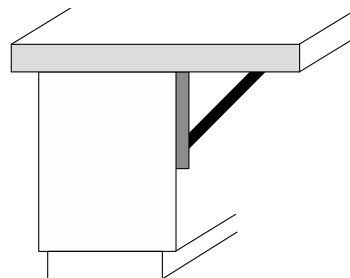

[14.2 - E]

- Brackets must be installed every 600mm (2') or less. Determine the number of brackets to fabricate by measuring the cabinet. Brackets must be long enough to reach within 127mm (5") of the countertop edge.
 - Fabricate the bracket plates that will be used to mount the brackets to the cabinet.
 - Drill screw holes into the bracket plate every 600mm (2') or less determined earlier to match up with the brass inserts in the brackets.
 - Fasten the brackets to the bracket plates using screws.
 - Fasten the bracket plates to the cabinet frame with wood screws before attaching the plywood underlayment.
 - Use one dab of silicone adhesive every 300mm (1') to 457mm (1'6") to secure Staron® worktop to the plywood underlayment.
 - Use one dab of silicone adhesive 1"(25mm) from the tip of each bracket.
- Apply dabs of silicone every 300mm (1') to 457mm (1'6") to the upper edges of the cabinets.

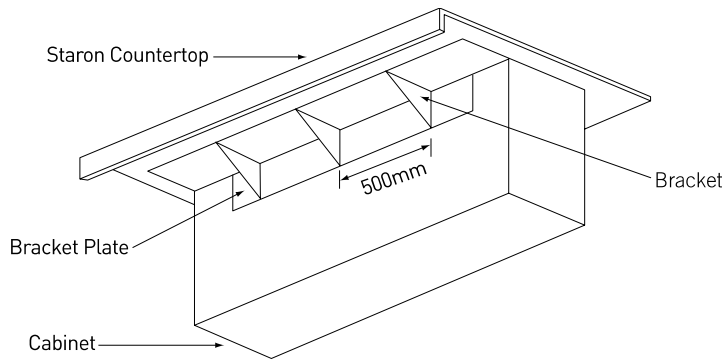

[14.2 - F]

16" or Larger Overhangs

6. Overhangs of 16" or more need to be supported to the floor.

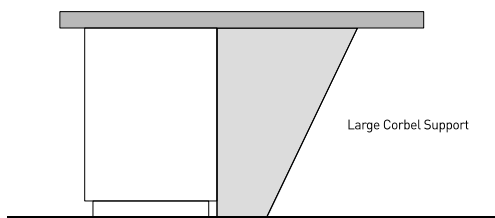

[14.2 - G]

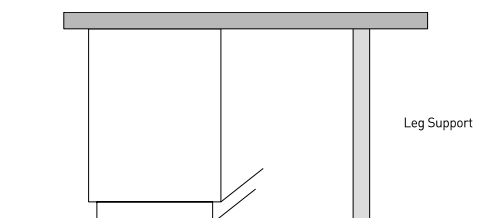

[14.2 - H]

TIP

Both Corbels and Legs could be made of Wood or from Staron®. You will need to support it every 3'.

Overhangs on Raised Bar

7. Overhangs on raised bars for kitchen tops, reception desks and other areas.

You can put full sub-tops on these overhangs.

However, make sure to leave $\frac{1}{8}$ " ~ $\frac{1}{4}$ " air gap between the wood and Staron® edge.

➔ Note

Because of the air gap and no walls, the materials have enough room to expand and contract.

Screw the plywood sub-top down to the wall using 3" coarse threaded screws.

When you silicone the top down to the plywood, use dime size dabs every 18".

Remember, too much silicone will not allow the top to move freely.

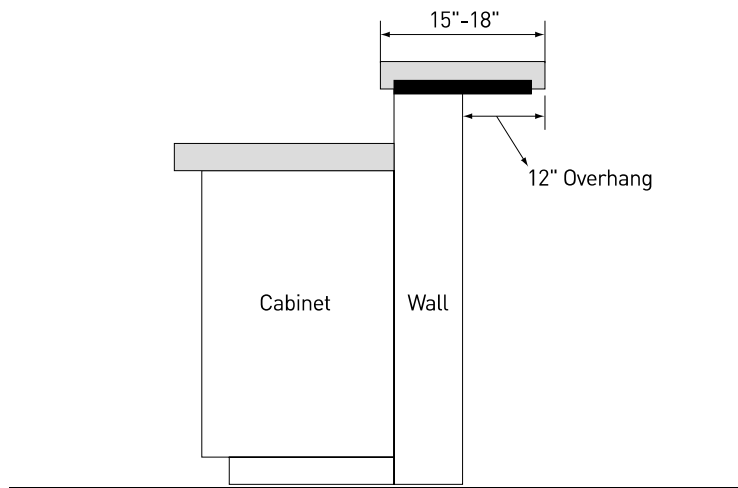

[14.2 - 1]

15.1 Handling Staron® Sink & Bowl

How to mount the Sink & Bowl

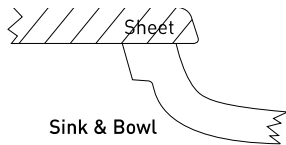

[Under Mount]

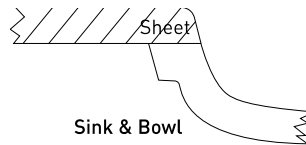

[Seam-Mount]

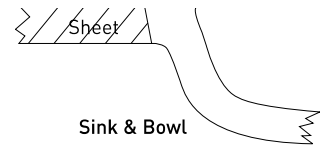

[Angled Mount(Bevel)]

Seam-mount (and Under-Mount)

Seam-Mount or Under-Mount is the mounting method that the face rim of the bowl is glued to the underside of the countertop..

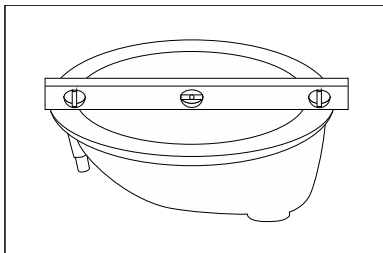

1. Check the bowl rim face for flatness using aluminum level.

2. Check sheet back for flatness

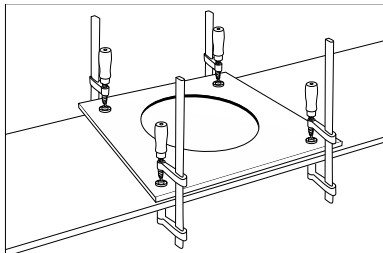

3. Clamp the template into position.

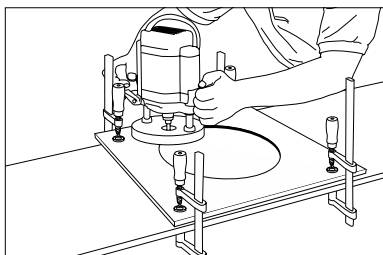

4. Use a router for all cutouts.

➔ **Note**

Any cutouts not using a router will be void from warranty.

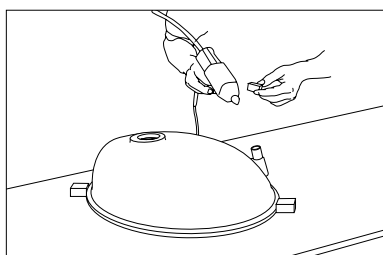

5. Remove the template, position the bowl and fix the bowl positioning blocks into position with hot melt.

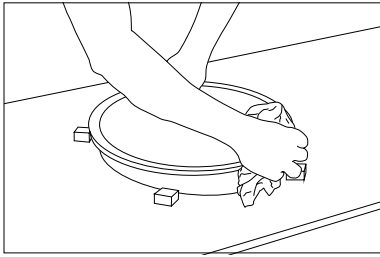

6. Sand the rim for proper glue adhesion.
Clean the rim face of the bowl with denatured alcohol.

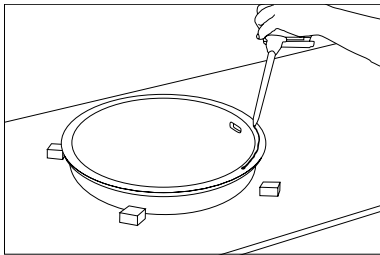

7. Apply Joint adhesive to the rim and glue into position.

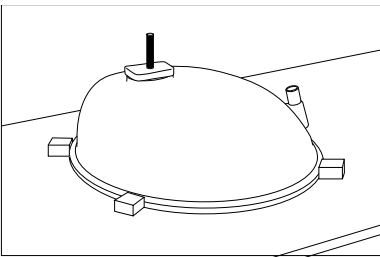

8. Fix them by using clamp and allow to dry.

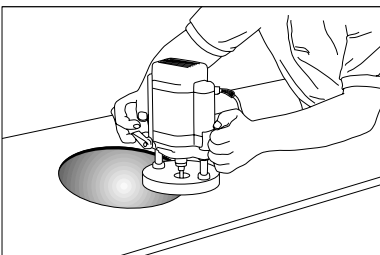

9. Turn the countertop over and route the surplus material to the edge of the bowl with the decorative bit to get the desired edge.

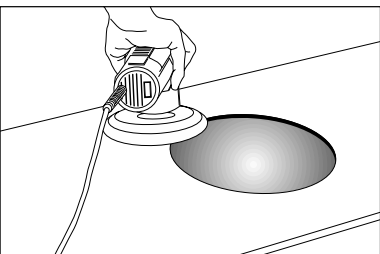

10. Polish the entire surface and bowl to the desired gloss level.

Overflow attachments for Bowls

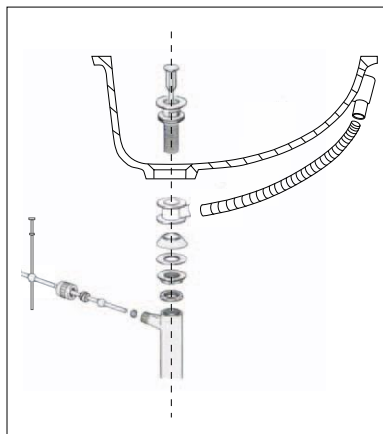

To install overflow attachments, connect all the components as illustrated. It is important to hand-tighten all joints after assembly and installation to prevent leaks.

After overflow attachments are complete, it is now ready to be connected by a plumber.

Angled mount

All the Staron® bowls have a 15 degree beveled edge, which enables the bowls to be dropped into the sheet so that it fits flush with the sheet surface.

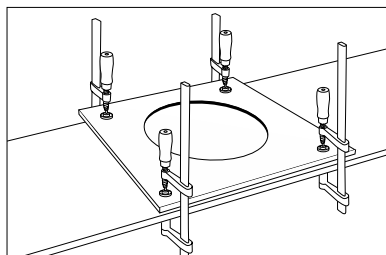

1. Clamp the appropriate template into position on the top of the sheet or countertop.

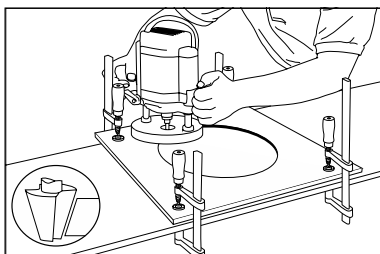

2. Route the bowl cutout with a 30mm sleeve guide and use the router in one motion

3. Route the cutout to a 15 degree bevel finish with an oblique router bit. The first pass should be set 12mm (1/2") below the top surface of the sheet.

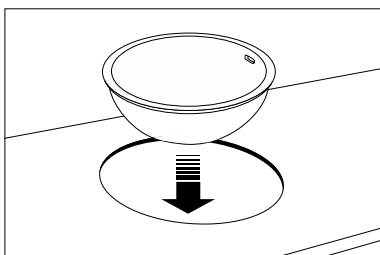

4. Drop the bowl into position for trial fit. The rim face of the bowl must protrude above the sheet to a maximum 0.2mm. If necessary, repeat step 3 several times.

5. Remove template.

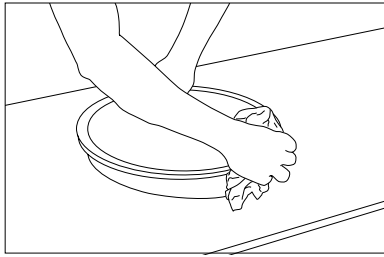

6. Clean the cutout edge and the edge of the bowl with denatured alcohol.

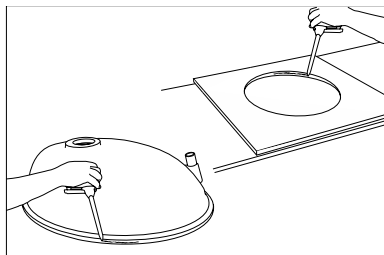

7. Apply Joint adhesive to the cutout edge and to the bowl, then glue them into position.

8. Fix them by using clamp and allow to dry.

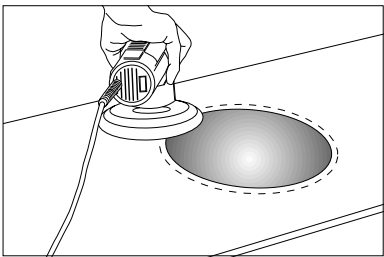

9. Level the sheet with sander.

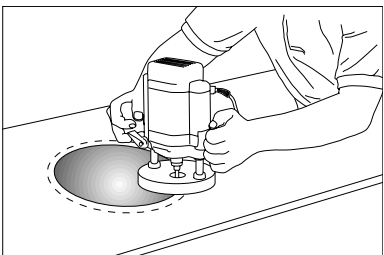

10. Make the edge of the bowl with the decorative bit to get the desired edge.

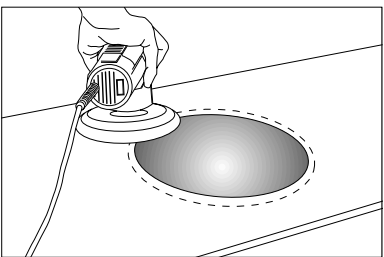

11. Polish the entire surface and the bowl to the desired gloss level.

Introduction

- Stainless Steel Bowls
- Cast Iron Bowls
- China Bowls
- Wood Insert
- Wood Edge Insert
- Laminate Inserts
- Handicap Handles and Bars-Shower / Tub Surrounds
- Shower Doors
- Soap Dishes / Shower Caddies
- Tile (ceramic)-Hot Pot Areas

16.1 Stainless Steel Sinks

Stainless Steel Sinks

Stainless Steel Sinks can be top mounted or under-mounted to Staron® Countertops.

Top Mounted / Drop-In

To top mount or drop in a Stainless Steel Sink, a hole needs to be cut in the countertop.

1. Layout the sink cutout on the counter. Mark the centerline on the top and draw a line with a square from front to back. The measurement back from the front edge should be the overhang + $\frac{3}{4}$ " for the cabinet face + $\frac{1}{2}$ " for space to accept the sink clips. This will be the front of the cutout.
2. Set up a plunge router (3 HP minimum) with a $\frac{1}{2}$ " x 2" (cut) 2 flute carbide router bit.
3. Plunge the bit into the material so the bit goes through the material. Freehand-run the router counter clockwise on the inside of the line traced out for the cutout. Wood template-Use a 1" template guide + $\frac{1}{2}$ " bit and run the router clockwise. Cutout the entire hole.
4. Once the hole is cutout, check to see if the sink fits. If it fits, the cutout is finished. If the sink does not fit, mark and trim as needed.

Under-mount

There are 3 different ways a stainless steel under-mount sink can look.

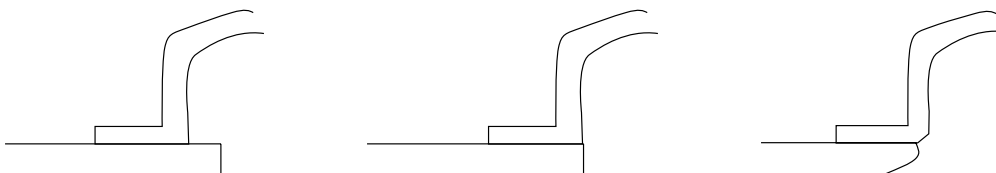

[16.1 - A]

1. Decide which method will be used.
2. Make a template to match the method that was chosen.
3. Cut out the sink hole.

SN-801-2016

4. Sand the cutout smooth with 150 grit (80 or 60 micron) sandpaper and a sander.
5. Route the cutout with ¼" radius bit.
6. Sand and finish the cutout to desired finish. See Finish and Polishing section. (18.1 page 87)
7. Flip the top over and center the undermount sink in place.
8. Hot glue the locating blocks. This will allow the sink to be put back in the same place after the silicone is applied.

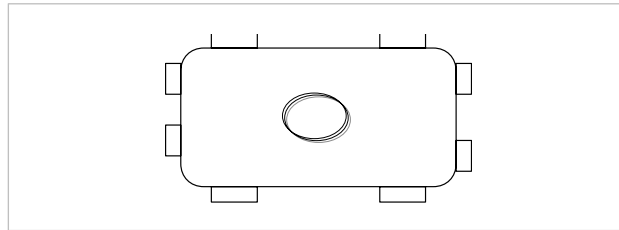

[16.1 - B]

9. Using sink clips from Air Draulics / Chemical Concepts, apply seam adhesive to the underside of the countertop where the clips will be placed.

TIP

Should use 3 clips for the front, 3 clips of the back, and 2 clips on each sides. These should be equally spaced. Make sure the entire base of each clip is covered with seam adhesive. Let it Dry.

10. Lift the sink off. Using denatured alcohol, wipe the rim of the sink and the area where the sink will sit. Let it dry.
11. Apply 100% color matching silicone to the area where the sink will sit.
This bead should be about ¼" wide and in the center of the area.

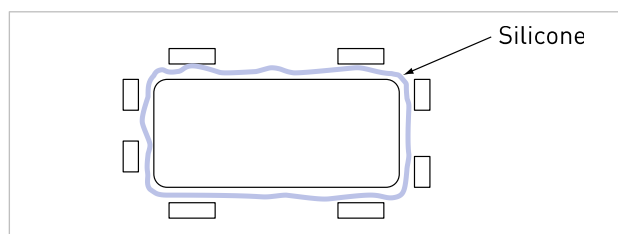

[16.1 - C]

12. Set sink in silicone.
Tighten the clips down all the way.
13. Once all the clips are tightened, get underneath the top and make sure the silicone is coming out all the way around the sink.
DO NOT FLIP THE TOP OVER UNTIL SILICONE IS FULLY CURED!
Spray silicone with denatured alcohol and wipe off the excess silicone.

TIP

If the top is flipped over before the silicone fully cures, the seal can be broken..

16.2 Cast Iron Sinks

Cast Iron Sinks can be either top mounted / drop-in or under-mounted.

Top Mount / Drop

Follow the same directions as the Stainless Steel Sink (Section 16.1).

Under-Mount

Follow the same directions as the Stainless Steel Sink Installation from steps 1-8 (Section 16.1).

9. Make a 1x3 wood frame. This frame needs to be attached to the inside of the sink base. Screw into cabinet and wall, making sure it will hold the weight of the sink, water, and any dishes in the sink.

➔ **Note**

Make sure the wood frame is ½" above the top of the cabinet and centered in the cabinet from side to side.

10. Place the sink on the wood frame.

Attach all plumbing to sink at this time.

11. Bring top in and fit in place. Move the sink around to set it in the center of the cutout.

12. Lift top off.

13. Apply silicone on the rim of sink using color-matching 100% silicone.

14. Set top back in place. Push top down all around sink to make sure silicone is coming out. If not, apply silicone bead where needed.

15. Spray silicone with denatured alcohol and wipe excess silicone off.

Do not move top or sink for 24 hours.

16.3 China Bowls

China bowls can be under-mounted following the same directions as Stainless Steel Under-mounts.

➔ **Note**

¼" overhang into the bowl is recommended.

16.4 Wood Insert

Wood inserts need to be fabricated using the following directions.

Do not use solid wood only as an insert.

Solid wood can be used, as long as it is backed up with a piece of Staron®.



[16.4 - A]

Flip the top over and lay out the wood first. The wood should be no bigger than $\frac{1}{2}$ the depth of the buildup. After the wood has been laid out, back it up with a piece of Staron®.

Seam only 1 layer on, at a time. After the seam adhesive is cured, the two pieces need to be sanded smooth. Next, the second layer can be applied.

Wipe everything down with denatured alcohol.

Hot glue the wood blocks to fix the pieces after the seam adhesive is applied.

Apply seam adhesive to the back pieces first.

Set the back pieces.

Apply seam adhesive to the backside of the wood between the wood and the back piece. Also apply the seam adhesive to the front edge of the top.

Clamp everything together.

When fully cured, sand the topside of the buildup smooth with 80-grit sandpaper using a sander. Make sure to keep the sander flat. Do not sand the front edge any more!

➔ Note

Remember that wood is softer than Staron® and will sand down faster.

When finished sanding, layout the bottom layer of buildup.

Wipe down with denatured alcohol.

Apply seam adhesive to the back and the front edge of the Staron® piece and to the wood piece.

Clamp the buildup on and let cure.

SN-801-2016

Once it is fully cured, route and sand the front edge as needed.

Finish to desired finish.

See Finishing and Polishing section. (Chapter 18)

➔ **Note**

Tape off the Staron® and stain the wood after everything is finished.

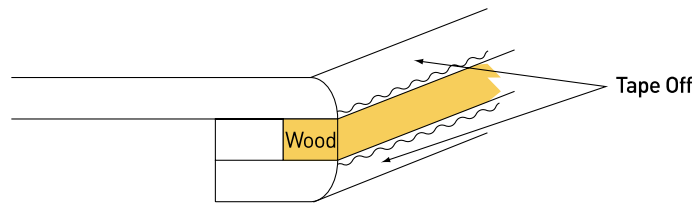

[16.4 - B]

16.5 Wood Edge

Wood Edge

To apply a wood edge to a piece of Staron®, the wood needs to be adhered with 100% pure silicone.

➔ **Note**

Because of dissimilar materials (wood and Staron®), the two will expand and contract at different rates. The silicone will allow this to happen.

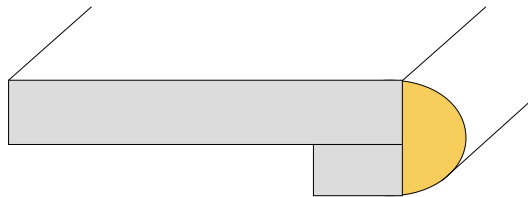

[16.5 - A]

Laminate Insert

Build the top the same as any other top with 2 layers.

After the top is finished, take a rabbet bit ($\frac{1}{8}'' \times \frac{1}{2}''$) and rabbet out where the laminate will go.

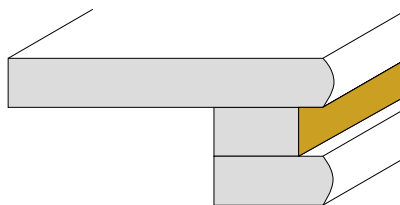

[16.5 - B]

Tape off the Staron® and apply contact adhesive to the rabbet and the back of the laminate.

Let it dry to touch and apply laminate to the top.

Push in place with a rag, making sure to put pressure all the way around the laminate.

Pull tape off and clean up.

16.6 Handicap Bars & Handles / Shower Doors

Handicap Bars & Handles / Shower Doors

Remember, all these need to be screwed into wood studs or blocking.
Locate studs / blocking where bars / handles or shower doors will go.
Drill a hole bigger than the screw being used.

TIP

Fill the hole with silicone. Then push the screw through.
This will act like a bushing.

Screw into the wood. It will void from warranty if screwed directly into Staron® products.

Note

Make sure when the Staron® is placed on the wall, there are no voids in the areas where you are placing the handles, bars or doors. If there are voids, the sheets can crack if the screws are tightened too much.

16.7 Soap Dishes / Shower Caddies

Soap Dishes / Shower Caddies (Made from Staron®)

Silicone and hot glue these to the sheets on the wall.
Nothing else is needed.
It is possible to use Seam Adhesive to adhere to the wall.

16.8 Tiles / Hot Pot Areas

Tiles / Ceramic / Hot Pot Areas

When inseting tile into a top, route out the area where the tile will go.
Route this area no deeper than 3/16".

Note

If the tile is thicker than 1/4" and the area needs to be routed deeper than 3/16", then a piece needs to be seamed under that area on the bottom side. This piece needs to be at least 2" bigger than the tile area, all the way around.
Set the tile in silicone. Grout with silicone.

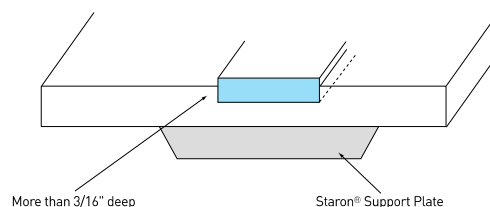

[16.8 - A]

Introduction

There are many different decorative options when selecting Backsplashes for Staron® countertops. Depending on customers' decorative need, they have the option to choose the Backsplash design, material, and decorative finishes.

When working with Staron® Solid Surface, there are three Backsplash options to choose from.

- Loose Splash (Set On Splash)
- Coved Splash
- Full Height Splash

17.1 Loose Backsplash

Loose Splash

Most common and widely used method, this Backsplash is set on the top of the countertop using mainly silicone. Loose Splash can be any height. Generally, they are 3" ~ 4" high and made of ½" thick Staron® Material. For the purpose of decorative feature, Loose Splashes usually have ⅛" radius routed on the top edge.

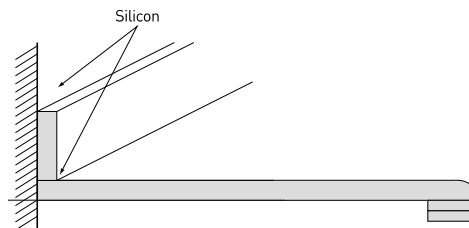

[17.1 - A]

Cut the backsplash strip to the desired width and length.

For ⅛" routed top-edge, lay the splash back side down. Clamp to the table.

Mark out where the splash is to get routed. Set up the ⅛" router bit in a router and route the splash.

(Make sure to run the router from left to right)

When finished routing, sand the splash. (Refer to Finishing and Polishing. (Chapter 18)

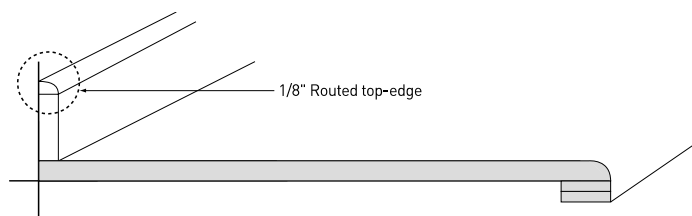

[17.1 - B]

To install a loose splash, run a bead of silicone on the deck (top).

Also, put dime size dabs on the back of the splash. Use hot glue to help hold the splash in place. Hot glue should be placed between the dabs of silicone on the back. These dabs of silicone should be spaced approximately every 12".

Set the splash in the bead of silicone on the deck and push tight to wall and deck of the countertop.

Lay bead of silicone in corner between the top and splash.

Make sure the bead of silicone touches the splash and the top.

SN-801-2016

Once the bead of silicone is placed in the corner, spray the bead and material with denatured alcohol.

If the silicone bead does not touch both the splash and the top, the denatured alcohol spray will seep under the splash and the silicone will not stick to either the splash or to the top. There will be a void in the silicone.

After the silicone and material have been sprayed, wipe the excess silicone out of the joint. Make sure to keep the joint area wet with denatured alcohol after every time the silicone is wiped off.

TIP

Use a laminate chip with a small 45° angle sanded on one corner.



[17.1 - C]

After the silicone joint has been sprayed, take the laminate chip and place in the corner. Pull the chip from one side to another and wipe off the excess silicone.



[17.1 - D]

17.2 Coved Backsplash

Although coved backsplashes are more complicated than the Loose Splash, It is preferred by many people due to its continuous look from the countertop to the backsplash.

Coved Splashes are not set on the countertop and caulked, they are seamed together with the countertop to make it one piece.

There are many different methods of accomplishing the Coved Splashes.

Following are couple of examples.

- Method A
- Hand Held Cove Router
- Shaper With Power Feed
- "V" Grooving

➔ **Note**

To reduce the chance of visible seams at the backsplash, Coved Backsplashes are not recommended to fabrication with Staron® product that has the larger particulates, such as Quarry, Talus and Breccia Series, unless V-grooved.

17.2-1 Method A(|)

Method A

Using this method, there are 3 pieces needed.

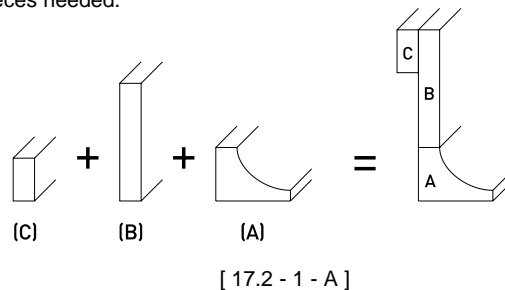

1. Cut a piece of material 5" wide, the length of the top. Set the piece face up on the table and clamp down. Take 3/8" cove router bit and rout one long edge. Make sure to set the depth of the bit to leave 1/8" of flat surface on the piece.

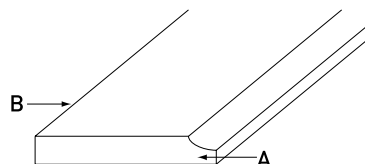

[17.2 - 1 - B]

➔ **Note**

This 1/8" flat surface will fit into a 1/8" rabbet routed into the deck of the top.

2. After the $\frac{3}{8}$ " cove is routed into the 5" wide piece, take a piece of the same material and stand it up on the 5" piece.

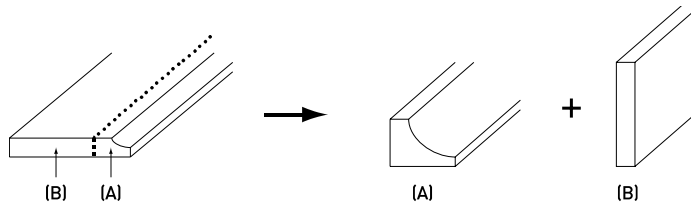

[17.2 - 1 - C]

Set the scrap piece on top of the 5" piece.

It should be flush with the $\frac{3}{8}$ " cove rout that was just routed in.

Take a utility knife and put a scratch in the top of the 5" piece, following the back of the scrap piece. This will give you the exact measurement needed to cut off the cove piece. This piece should be approximately $\frac{7}{8}$ " (+/-).

Set the table saw up with a sharp blade and set the fence to the desired width.

(Distance from front edge to scribe line.)

Cut this piece off the 5" wide piece. This piece will become the cove part of the splash. After cutting this off, the rest of the 5" piece becomes the splash piece.

3. Place release paper / tape down on the table and set both pieces on the release paper / tape.
The splash should be faced up.

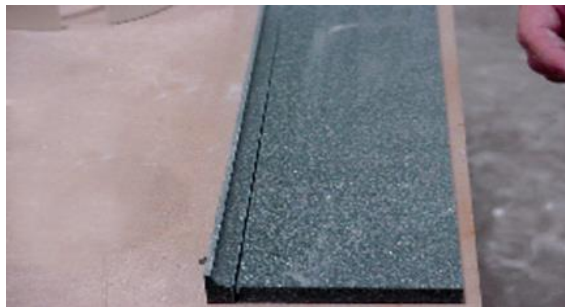

[17.2 - 1 - D]

4. Make sure to abrade the bottom edge of the splash and top of cove piece.
5. Wipe down with denatured alcohol.
6. Place seam adhesive on the cove piece. ($\frac{1}{4}$ " wide bead in the middle of the piece.)

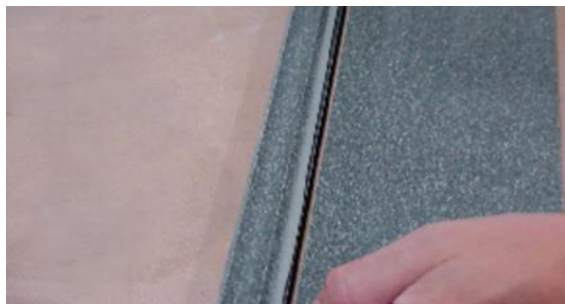

[17.2 - 1 - E]

Flip the cove piece on its backside and clamp to the splash using dani-clamps.
Let it cure.

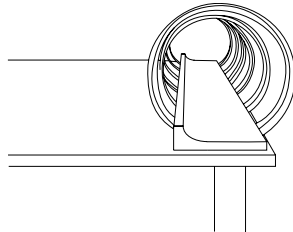

[17.2 - 1 - F]

7. Once the seam adhesive is fully cured, cut down the new covered splash to its final size. Use a table saw and cut down to 4 1/8" overall.

➔ **Note**

This will make a 4" high coved splash. The 1/8" rabbet routed into the deck of the top will take up the extra 1/8".

8. While the splash is still loose, sand off the excess cured seam adhesive. Use an orbital sander.
9. Finish sanding and route the entire splash to the desired finish.

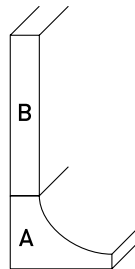

[17.2 - 1 - G]

▣ **TIP**

Use a profile (soft) pad. This will allow the pad to curve to the cove. Be careful not to push too hard into the cove. This could deform the cove.
Start out with 80-grit paper. This will take down the seam adhesive fast.

10. With the deck of the top facing up and the back of the top facing out, take a rabbet bit or wing cutter and route a rabbet 1/8" deep and 3/8" wide, along the entire length where the splash will go.

➔ **Note**

The depth of the rabbet should be the same as the lip left on the cove part of the splash.

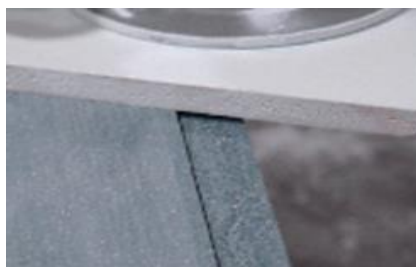

[17.2 - 1 - H]

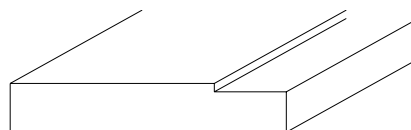

[17.2 - 1 - I]

11. Once the rabbet is finished, abrade the rabbet and the bottom of the cove splash.

TIP

With a block sander and 80 grit sandpaper, sand the bottom edge of the cove splash on a slight angle. This will allow the splash to fit easily into the rabbet.



[17.2 - 1 - J]



[17.2 - 1 - K]

12. It is very important to keep the splash square to the deck. One simple way of doing this is to cut some wood blocks (MDF or particleboard) 4" by 4" with a 45 degree cut on the bottom.

Cut approximately 2 per foot of splash. These will be hot glued down to the deck.

The reason for the 45° cut is so the wood blocks can be pushed as close to the splash as possible.

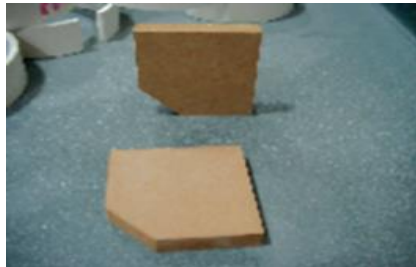

[17.2 - 1 - L]



[17.2 - 1 - M]

13. Dry fit the splash and clamp in place. Once this is done, start placing the wood blocks on the top. One should be placed about 2"~ 3" in from each end. Then, they should be placed every 12" from there.

Place hot glue on the bottom of the wood block. Push the block against the splash to make it 90° to the deck.

Push the wood block down to the deck and hold until the hot glue sets up. Repeat this step with every wood block needed.



[17.2 - 1 - N]

Once all the wood blocks are set, take all the clamps off. Set the splash upside down, so the bottom is facing up. (Lean against wood blocks.)

14. Wipe down the bottom of the splash and the rabbet with denatured alcohol.
15. When the denatured alcohol is completely dry, apply the seam adhesive to the rabbet area.
Place $\frac{1}{8}$ " bead to the front of the rabbet and a $\frac{1}{4}$ " bead on the backside, approximately $\frac{1}{4}$ " in.

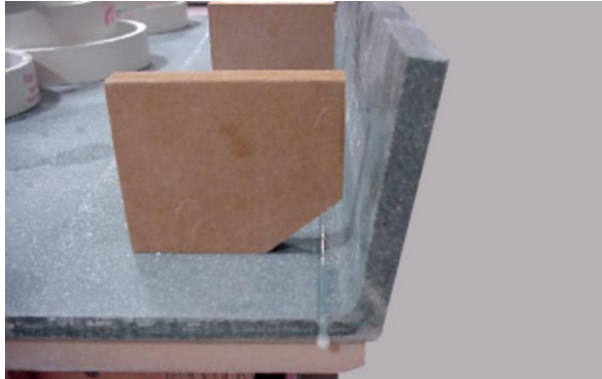

[17.2 - 1 - O]

 **TIP**

When setting the splash into the seam adhesive, set it half way into the $\frac{1}{8}$ " bead in front and push forward. This will ensure that the seam adhesive will be under the splash and in the front seam.

16. Clamp the splash downward and from front to back. This will make sure the splash is down all the way and still kept at 90°.

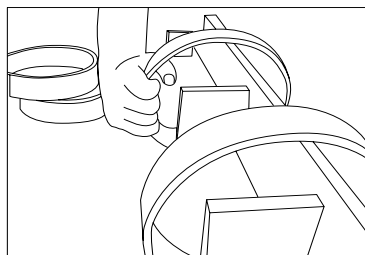

[17.2 - 1 - P]

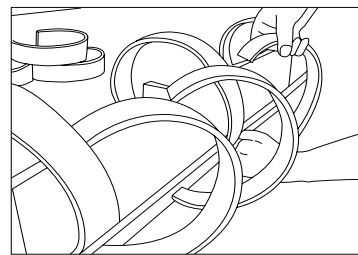

[17.2 - 1 - Q]

17. Let the seam adhesive fully cure. After the seam adhesive is fully cured, take the wood blocks off the top and clean up the hot glue. Sand down the excess seam adhesive with an orbital sander using 80 grit sandpaper. This will take the adhesive down fast.

 **TIP**

The splash piece should already be sanded to finish. Be careful not to sand the cove area too much. Only sand the seam adhesive off and part of the deck.

18. Sand this area to the desired finish.
Refer to Finishing and Polishing (Chapter 18)

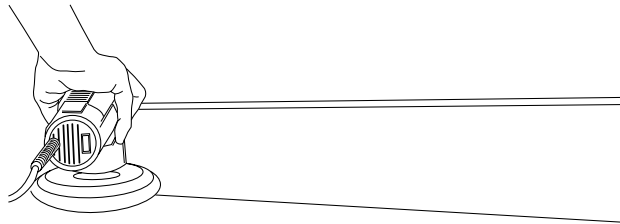

[17.2 - 1 - R]

19. The lower seam of the splash and the deck should be sanded to finish. Now, hand sand the actual cove part of the splash until it reaches the same finish. This will blend the splash and deck areas.
If there is a side splash, follow the same directions mentioned above.
20. Miter both splashes to meet in the corner.
This should be done before seaming the splashes onto the deck.
21. When finished seaming the two splashes together, hot glue two blocks onto the outside of the splashes in the corner.
This will allow the splashes to be pulled together with a clamp. This will ensure a tight seam.

TIP

While the seam adhesive is still wet, wipe the excess adhesive from the corner.
This will make it easier to finish the inside corner.

22. There may be a need to add a scribe strip to the back of the splash.
This will allow the top to be fit to the wall.

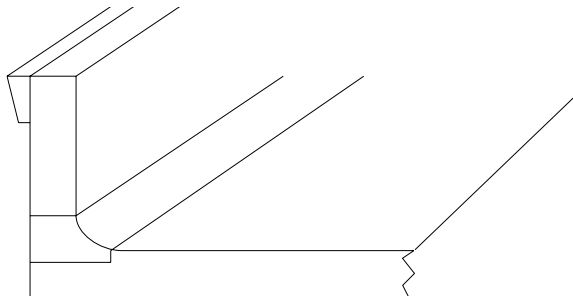

[17.2 - 1 - R]

Decide how much of a scribe is needed. Cut a piece of material to match.

23. Dry fit this piece flush with the top of the splash. Clamp this piece on.

Once it is clamped and fit, hot glue some wood blocks under the scribe piece to the back of the splash.

24. Wipe down both the scribe piece and the back of the splash with denatured alcohol.

25. Apply the seam adhesive to the scribe piece and clamp to the splash.

26. Let the seam adhesive fully cure. Sand the top smooth to the desired finish.

27. Scribe the top to the template. Using a grinder or belt sander, sand down the scribe piece to the line that was just drawn.

TIP

When sanding the scribe piece to the line, tilt the grinder or belt sander on a slight angle towards the splash. Later, this will make it easier to fit the top on the job.

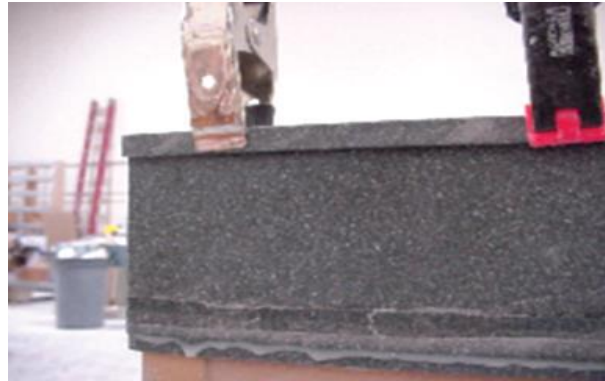

[17.2 - 1 - T]

17.2-2 Method(II)

Hand Held Cove Router

1. Cut a piece of material $\frac{3}{8}$ " smaller than the height of the splash.
2. The next piece to be cut should be $\frac{1}{2}$ " x $\frac{7}{8}$ " x length of the top.
3. Abrade the two pieces and wipe down with denatured alcohol.
4. Seam these two pieces with seam adhesive perpendicular to each other.

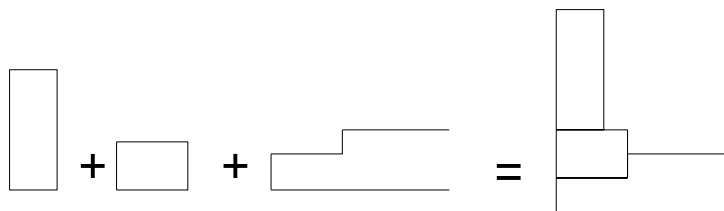

[17.2 - 2 - A]

5. Clamp these two pieces together using dani-clamps. Set the clamp every 6" for the entire length.
6. While this is drying, rabbet the deck of the top $\frac{1}{8}$ " deep and $\frac{7}{8}$ " with rabbet bit.



[17.2 - 2 - B]

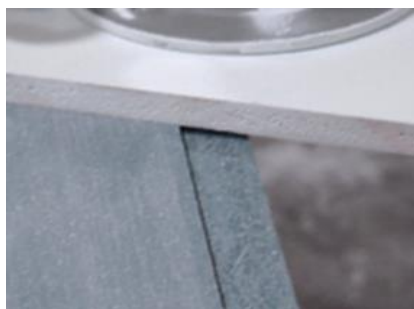

[17.2 - 2 - C]

➔ **Note**

If there is a side splash, make sure to wipe the seam adhesive from the inside corner of one piece. This needs to be clean and clear of seam adhesive to accept a $\frac{3}{8}$ " x $3 \frac{5}{8}$ " x $\frac{7}{8}$ " piece of material. This will become the inside corner for the splash.

7. It is very important to keep the splash square to the deck. Refer to the previous cove splash section (Steps 12-16 page 129). Let the seam adhesive cure.
8. Remove the clamp and wood blocks.
9. Set up the cove router so the bit touches the deck and the splash.



[17.2 - 2 - D]

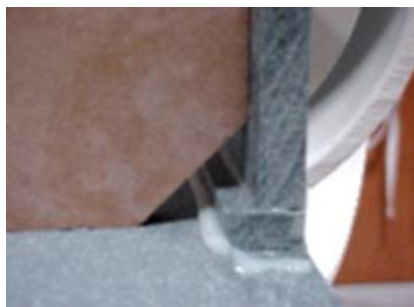

[17.2 - 2 - E]

10. Run the router from left to right; making sure to keep the router tight up against the splash.

➔ **Note**

The router has a 90° wall on both sides of the base. This allows the bit to go all the way into the corner without going too far.

11. Sand the splash and cove area with 150 grit (100 micron) sandpaper to make it smooth. While sanding this area, also sand the deck area near the cove splash.
12. Sand the entire splash, cove, and deck to desired finish.
Refer to Finishing and Polishing Section. (Chapter 18, page 87)

If there are side splashes :

At step #7, set the corner piece in.

Cut the side splash square on the mitre box.

Clamp all three pieces together and seam together.

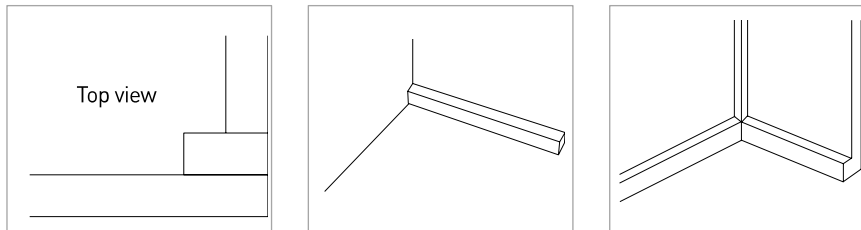

[17.2 - 2 - F]

Remember, the inside corner has to be coved also. To do this, the cove router has to be run up the inside corner. There are two different recommended methods.

- A. Tilt the router on its side and pivot the router up the corner.
- B. Raise the router up the corner.

Be careful not to cut too deep when route plates go above splash.

Once the corner is routed, the only way to sand this area is to sand it by hand.

Sand to desired finish.

17.2-3 Method(III)

Shaper With Power Feed

- This involves a little more investment.
- It is a quick way to make a coved splash.
- There is still a need to seam a "L" shape piece together.
- After seaming this "L" together, run the piece through the shaper.
- With this system, it will save a lot of fabrication time.
- This system routs off all the excess glue from the top seam.
- This leaves very little sanding to do on the splash.
- After this is done, follow steps #11~27 in section #1.

17.2-4 Method(IV)

"V" Grooving

This is the quickest way to make a coved splash. But yet, it is the most expensive as far as equipment is concerned. This system involves running the entire sheet through the "V-groover"

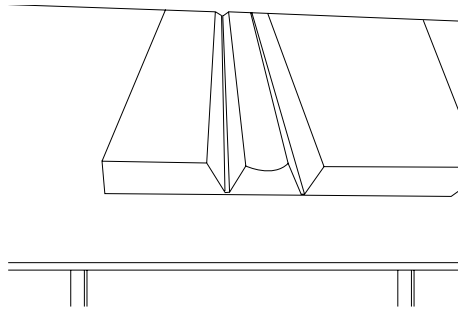

[17.2 - 4 - A]

After running the piece through the machine, wipe out the grooves with denatured alcohol. Then, place seam adhesive in the grooves and fold up.

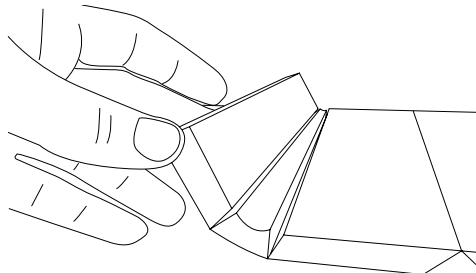

[17.2 - 4 - B]

Using recommended tape, tape the splash in place.
Check with "V-Groove" Manufacturer for further details.

17.3 Full Height Backsplash

These splashes run from the top of the counter to the bottom of the upper cabinets.

After the counter is installed, measure for the full height backsplash.

If possible, make a template of the wall where the splash will go.

Alternatively, you can take measurements but mistakes could easily happen.

Using cardboard is the best way to make a template for the full height backsplash.

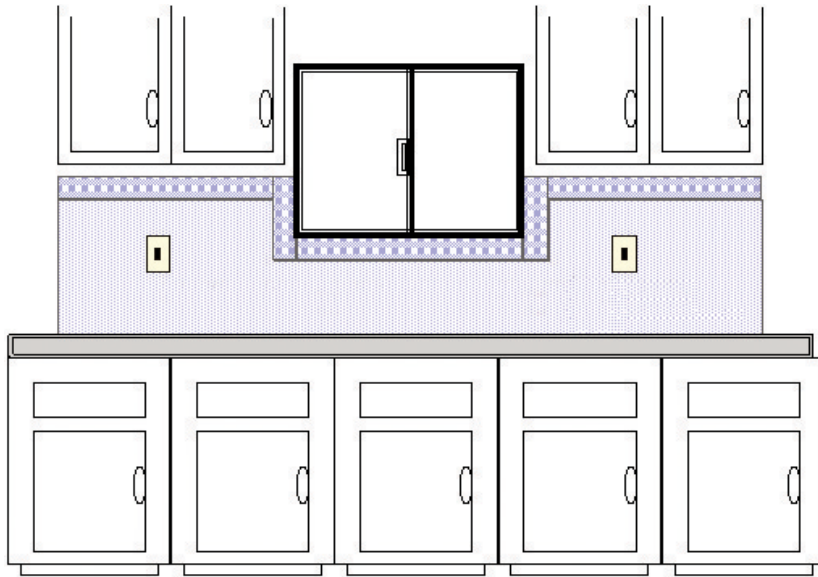

[17.3 - A]

Cut the cardboard to $\frac{1}{2}$ " short of overall height and length. If there are different heights, such as under a window or microwave, cut the pieces separately. Make these pieces longer than needed by about 8".

This will allow for overlapping and gluing.

Once all the pieces are cut to size, hot glue them together.

After the pieces are glued, cut $1\frac{1}{2}$ " wide strips and hot glue to cardboard, making sure to butt the cardboard strips to the underside of the upper cabinets. This will give an exact template of the splash.

Precut the $\frac{1}{4}$ " thick material $\frac{1}{4}$ "~ $\frac{1}{2}$ " over size of template. If the splash is longer than what the sheets come in, seam a piece on to make the piece longer than the template.

Once the material is longer than the template, lay the template on the material and trace out (Lay the template flush with the bottom of the material).

After tracing is finished, use a router and straight edge to cut the material to size.

TIP

Cut the outlet or switch holes with a router or a rotozip™.

DO NOT USE A JIGSAW! Make sure to leave enough material so the ears on the switch or outlet can rest on top of the backsplash.

It is the time to finish and sand the entire sheet to desired finish.
Also, rout $\frac{1}{8}$ " on any open sides and sand.
(Refer to Finishing and Polishing section. Chapter 18 page 87)

For installation

1. The outlets and switches need to be pulled out.
2. Place pure silicone on the back of the full height splash. Run a continuous bead of silicone all the way around the perimeter of the sheet. Run a continuous bead around all cutouts. Place dime size dabs 12" apart across the rest of the sheet.

➔ Note

A licensed Electrician should do the electrical work.

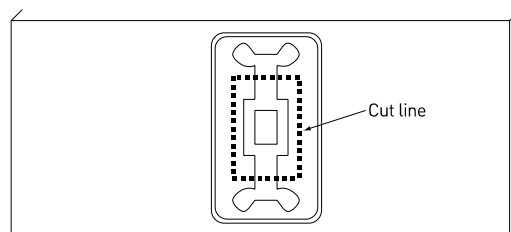

[17.3 - B]

3. Get the piece in place before setting against the wall. Place a few dots of hot glue on the back of the sheet (where there is no silicone). This will hold the sheet in place until the silicone cures. Curing takes approximately 24 hours. Quickly push into place. Make sure to push around the entire backsplash to make sure all the silicone is touching the wall and splash.
4. Replace outlets and switches.
5. Put the covers on the outlets and switches.
6. Caulk the joint between the splash and top with 100% clear silicone.
Lay a bead of silicone in corner between the top and the splash.
Make sure the bead touches the splash and the top.
Spray the bead and material with denatured alcohol.

➔ Note

A licensed Electrician should do the electrical work. The silicone bead needs to touch both the splash and the top. If it does not, the denatured alcohol will seep under the splash and the silicone will not stick to either the splash or the top. There will be a void in the silicone.

After the silicone and material have been sprayed, wipe the excess silicone out of the joint. Each time the silicone is wiped off, make sure to keep the joint wet with denatured alcohol.

■ TIP

Use a laminate chip with a small 45-degree angle sanded on one corner.

After the silicone joint has been sprayed, take the laminate chip and place it in the corner. Pull the chip from one side to the other and wipe off the excess silicone.

7. Finally, caulk (silicone) the joint between the backsplash and the bottom of the upper cabinets. Repeat step #6

18.1 Finishing

Questions to be answered before sanding!

Decide what kind of sandpaper to use:

Standard grit	Average size of grit
Micron Paper / likeness	All grit the same size
Abralon	Can be used wet or dry
Trizact	Must be used damp

We suggest Micron, Abralon, or Trizact for the best result.

Decide what finish the top will have:

Matte	Most common / easiest to maintain
Satin	Most common / easy maintenance
Gloss	High maintenance
Mirror	Extra high maintenance

➔ Note

Any dark colored solid surface product requires a higher gloss than a Matte finish and also requires additional maintenance and care to retain its original luster. Therefore, dark colors are not recommended in high traffic area as where scratching may frequently occur.

Check to see if the color of the sheet is light or dark.

Once these decisions have been made, look at the chart in this section for the grits needed to get the desired finish on the color sheet.

Finish	Standard Grit	Micron-3M	Abralon-Mirka	Trizact-3M
Matte Finish (Light Color)	120, 150, 180, Red scotch brite	80, 60, Red scotch brite		
Matte Finish (Dark Color)	120, 150, 180, 220, 320 Grey scotch brite	80, 60, 30, Grey scotch brite	180, 360, Grey scotch brite	
Semi-Gloss	120, 150, 180, 220, 320, 600-(Wet)	80, 60, 30, 15	180, 360, 500	60 micron Blue, Green Orange, White All Wet
High Gloss	120, 150, 180, 220, 320, (600, 800, 1,000) Wet	80, 60, 30, 15, 9, 5	180, 360, 500, 1,000, 2000, 4000	
Mirror Finish	All of the above plus 1) Marine grade rubbing compound 2) Finesse it compound 3) Liquid Glass as coat.			

[18.1 - A]

▶ TIP

We suggest Micron-3M, Abralon, or Trizact for the best result.
This Chart is only a guideline

SN-801-2016

Method of Sanding

When sanding, make sure to sand in the same direction, every step of the way.
Always sand the top, front to back, side to side and circular motion (clockwise).
The circular motion should be done clockwise in both directions.

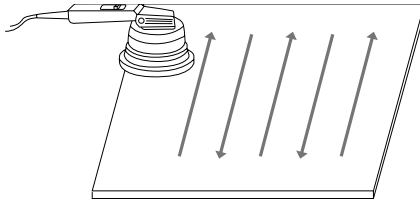

[18.1 - B]

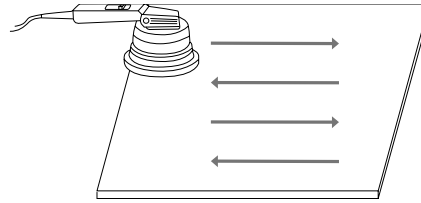

[18.1 - C]

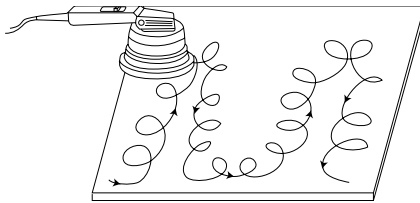

[18.1 - D]

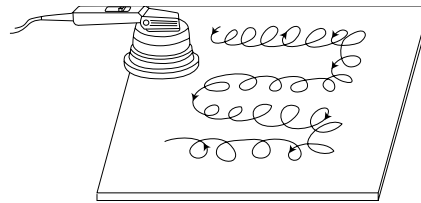

[18.1 - E]

TIP

Make sure to wipe dust off after each grit. This dust is the same size as the paper just used. If the next grit is used without wiping it down, then there will be scratches left behind, the size of the previous sandpaper.

Make sure to overlap $\frac{1}{2}$ the distance of the pad on the sander.

Example : 6" pad = 3" overlap

Note

If the circular motion is done counterclockwise, this will leave swirls or pigtails.

18.2 Polishing

Polishing

To high polish a top, there are 3 extra steps that needs to be done after all the steps of Finishing are completed.

1. Marine Paste Rubbing Compound
2. Final Glaze
3. Liquid Glass

Procedure s:

1. Sand the top to a gloss finish.

➔ Note

Make sure that you wipe the top to clean all dusts between each grit of sandpaper.

We recommend the use of Dani Designs polishing system. This system has 3 specially designed polishing pads.

These pads fit on most random orbital sanders that accept a 5/16" threaded post.

Each of the pads uses special compound.

Pad #1 Used with 3M 's Marine Paste Compound

Pad #2 Used with Finesse-it Compound

Pad #3 Used with Liquid Glass

2. Use pad #1 and 3M®'s Marine Paste Compound. Spread a little paste on the area to be polished. Make sure to set the pad into the compound and coat the pad. Sand the top just as you would with sandpaper on the sander. Use the same method front to back, side to side, and a clockwise circular motion.
3. Wipe down the countertop, making sure to get the entire compound residue off.
4. Change the pad to Pad #2.
5. Follow Step #1, except using Pad #2 and the Finesse-it Compound®.
6. Wipe down the countertop of all compound residue.
7. Follow Step #1, except using Pad #3 and Liquid Glass®.
8. Once the Liquid Glass® has been worked into the top. Wait about 5 minutes, then buff the surface. The polish will dry and get hazy When buffing, use the same pad, moving quickly.

➔ Note

Liquid Glass® can be found in an automotive store.

This polish is used on clear coat finishes for cars.

▶ TIP

With this system, if there are minor scratches caused by installation, there is no need to resort to sanding.

The minor scratches can be taken out with using just buffing pads and compound. It will blend right in.

19.1 Transportation

The best way to transport the Staron® top is standing up on edge.

Always put blankets between tops. This will keep the tops from banging against each other and prevent a possible damage.

This method can be used in any kind of truck or cube van. Build an "A" frame in the truck or use "A" frame carts with wheel and wheel locks.

Always strap tops to the cart and strap the cart to the truck.

Tops can be transported flat, but make sure all areas are supported well.

The weight of the top can cause stress in the top, especially when hitting bumps on the road.

19.2 Site Preparation

Check to be sure cabinets are flat to within 1/8".

Shim to flat, if necessary.

If the top is installed on uneven cabinets, over 1/8", it will void the warranty.

Make sure there is support around all cabinet openings. 1 x 3 wood between cabinets at DW, back wall. 1 x 3 wood on back wall around lazy susan area.

➔ Note

Screw these into 2 x 4 studs with coarse threaded screws and make sure they are level with the cabinets.

■ TIP

Cover all heat and AC vents in floor or near where the top is being installed.

This will save headaches down the road. Dust will settle in these vents until the customer turns on the heat/AC. Then, the dust from the installation will blow throughout the house. The customer might call and complain and possibly send out a bill.

Put up plastic around doorways. This will keep the dust contained to the room you are working in.

19.3 Carrying & Positioning

Always carry the top on edge. **Do not carry the top flat!**

When setting the top in place, set back edge on cabinet first.

Then slide back of the top to the wall and set the front edge down.

➔ Note

Make sure to have at least two people carrying and setting the top in place.

It is important that you work together.

Do not get the top twisted or jammed in place.

This will cause stress in the top and possibly break.

19.4 Dry Fitting

Dry fit the seam after setting the top in place.

➔ Note

- Make sure to leave $\frac{1}{8}$ " gap at walls for expansion.
- Expansion gaps should be $\frac{1}{8}$ " per 10' of top between walls.
- Shim top as needed. Everything should line up. The top should be flat.
- Scribe the top as needed.
- Scribe with a 4" angle grinder and 50 grit disc.
- A belt sander can be used carefully. Do not heat up the material.

▶ TIP

- When scribing the top, angle the top back at a slight angle.
- This will help when fitting tight to the wall.



[19.4 - A]

- Abrade seam with 80-grit sandpaper.
- Make sure not to hit the top $\frac{1}{16}$ " of routed seam.

19.5 Seam Plate

- The top should touch the whole seam plate. If the seam plate is lower than the bottom of the top, then shim up the seam plate.
- Make sure everything stays flat and lined up.
- Set up whatever clamping system is to be used. Clamp up the seam, without seam adhesive.
- After the top is clamped dry, check to see if the seam disappears.
- If it does, then everything should be lined up correctly.
- The top is almost ready for the seam adhesive.
- Check to see if the cook-top fits. If it does not, then cut the cutout bigger.
- It is easier to do this now, rather than after the top is finished.

19.6 Faucet Holes

- Use a standard hole saw ($\frac{1}{4}$ " pilot bit).
- Kitchen faucets should use $1 \frac{3}{8}$ " hole saw. The center of the hole should be $2 \frac{1}{4}$ " back from the inside of the bowl.
- Vanity faucets should use $1 \frac{1}{8}$ " hole saw. The center of the hole should be $2 \frac{1}{8}$ " back from the inside of the bowl.

➔ Note

- Do not twist the drill in the hole. This will cause stress in the top and it could break the top.
- Be careful not to push too hard on the drill. If you push too hard when the hole is almost all the way through, the drill will slam into the deck of the top. This could cause a crack in the top.
- A $\frac{1}{8}$ " radius can be routed around the hole. But, it is not necessary.
- There is very little stress in this area.

19.7 Final Placement

Once everything is in place and ready to go, wipe the seam area and seam plate area with denatured alcohol.

➔ Note

Make sure to wipe the underside of the top around the seam area.

Check to see that there is no ink from the sheet numbers in this area.

If the seam adhesive touches the ink, it could seep into the seam and discolor the seam.

Lift the top off the cabinets and carefully set it down. Place dime size dabs of 100% clear silicone every 12"~15". Set the largest piece in place first.

Do not set the smaller section to be seamed in place now.

Get the seam adhesive ready to go.

Lift the large piece so that seam adhesive can be applied to the top of the seam plate.

Once the seam adhesive is in place, set the large top down. Now, silicone where the smaller piece goes.

Set the smaller piece in place. Leave about 1/8" gap between the two pieces.

Seam adhesive should already be on the seam plate.

Fill the 1/8" gap with seam adhesive. Start at the underside, in the front and work up towards the deck.

▶ TIP

Tape off the front of the cabinets. If the seam adhesive drips down, it will not stick to the cabinets.

Have a laminate chip ready to clamp to the underside of the seam area in the front. This will help keep the seam adhesive in the seam and not on the floor or the cabinet. Make sure to clamp the shiny side up towards the seam adhesive.

This way, the seam adhesive will not stick to the laminate chip.

Once the front edge is filled, clamp the laminate chip in place on the underside.

Fill the gap from back to front. Pull the seam adhesive instead of pushing the seam adhesive.

Pull the seam together with whatever clamping method is decided.

Let it fully cure!

After the seam adhesive is fully cured, sand the seam with 80-grit to start.

Finish to the desired finish. Blend it into the rest of the top.

➔ Note

Everything should have been sanded except 6" on either side of the seam.

All of these should be done in the shop. The seam area is the only area left to finish at the installation site.

Make sure to feather out the seam area with each grit of sandpaper.

Do not stay in one area. If you do not keep moving, it will create a valley effect.

Clean up inside and outside.

▶ TIP

Leave the site cleaner than you found it. This will go a long way with the customer.

Install the backsplash at this time.

19.8 Anchoring Dishwasher

There are two ways to anchor a dishwasher.

- 1) ¼" Brass anchors (push in type)
 - Drill ¼" hole ½" deep. Push the anchor in.
 - Screw through dishwasher bracket into anchor.
- 2) Piece of wood behind solid surface buildup-siliconed in place.
 - Screw ¾" wood screws through dishwasher bracket into wood.
 - DO NOT SCREW DIRECTLY INTO Staron®**

19.9 Preparing Cooktop Cutout

- 1) Place Heat-Conductive Aluminum Tape (One layer of 4 mils, at least 2" wide, ex: 3M 425 Aluminum Foil Tapes or similar) around the cutout.

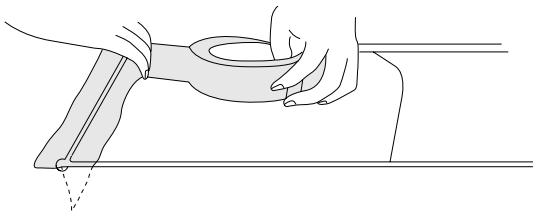

[19.9 - A]

Put two continuous layers of heat tape around the cutout.
Overhang the top by ¼" and let the rest hang down.

➔ Note

Everything should have been sanded except 6" on either side of the seam.
All of these should all be done in the shop. The seam area is the only area left to finish at the installation site.
Make sure to feather out the seam area with each grit of sandpaper.
Do not stay in one area. If you do not keep moving, it will create a valley effect.
Clean up inside and outside.

19.10 Do's and Don'ts

Do's

- Clean with soap and water, using a sponge.
- Use a Scotch Brite™ with soap and water on the top to get stains out.
- Clean with ammonia based products (Windex™, 409™, etc.).
- Run cold water in sink when dumping boiling water.
- Use cutting boards, whenever possible, to protect the top.
- Use trivets or hot plates, instead of putting hot pans on the top.
- Fill the sink with water and ¼ cup of bleach. Let set for about one hour. Rinse and scrub with a Scotch Brite™ pad. This will make the sink look new.

Don'ts

- Do not use Comet™ or Ajax (anything abrasive) on the top.
- Do not cut directly on the top.
- Do not use the Scotch Brite™ pad dry. It will act like sandpaper.
- Do not set anything hot on the top. Always use a trivet or hot plate.

TIP

Always leave at least two square feet of color matching material with the job. This is for future use, in case the top gets damaged. (Store it in safe place for future use)

Square these off and route with ⅛" radius on the top and bottom. Sand and put rubber feet on the bottom. Customers always love these cutting boards since they were not expecting it.

20.1 Overview

In addition to creating beautiful Countertops, Staron® 100% Acrylic Solid Surface can be used in many different applications. Ranging from furniture, sign, shower wall, stair rail.....

- Shower walls
- Tub Surrounds
- Wainscoting

All of these applications are fabricated and installed in a similar way.

20.2 Fabrication and Installation

Measure or template the walls.
Cut the pieces oversized by around ½", all the way around.

➔ Note

If sheets are seamed together, make sure it is safely handled.
Trace out the template or layout the measurements on the sheet. Cut to size with a router.
Sand to desired finish. See Finish and Polishing section.

Make sure there is at least a ⅛" gap on each side if the sheet runs between walls. This is for the sheet expansion and contraction.
Do not seam inside corners in shower surrounds or tub surrounds.
Corners must be filled in with 100% silicone. The outside corner can be seamed.

Dry fit the pieces after everything is cut to size and sanded.
Attach to the back walls first and the side walls.

➔ Note

After the back wall is installed, measure for the faucet holes.

To attach the walls, place a bead of 100% silicone all around the perimeter of the sheet. Then, place quarter size dabs of silicone every 12".

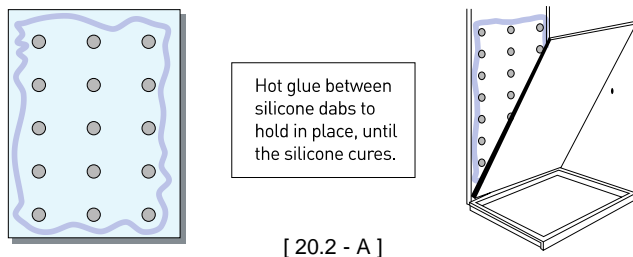

The bead will seal the backside and the dabs will pull the sheet to the wall when fully cured.
After the back wall is in place, dry fit the sidewalls. Scribe as needed against the back wall.

➔ Note

Sidewalls should be tight against the back wall.
If there is a glass door being installed, leave a ⅛" gap at the door side of the sheet.

SN-801-2016

Cut the faucet holes with a router or Rotozip™ type tool.

Do not try and cut these holes while the sheet is on the wall.

Silicone as needed to attach the sidewalls.

Once all the walls are installed, wipe down with denatured alcohol.

Silicone all joints with color matching 100% silicone.

Spray with denatured alcohol and wipe the joints clean.

See loose backsplash section.

TIP

Remove excess silicone before it gels with a putty knife and clean it in a couple of minutes.

Start at the bottom and work your way up. This keeps the alcohol from getting into the joints before the silicone is cured.

If the denatured alcohol gets into the joint before the silicone, the silicone will not stick. It will not seal.

If the sheets cannot be seamed for some reason, there are two other ways to line the sheets up or hide the seam area.

1. Batten Strip

Using a piece of material, approximately 2" wide set over the seam.

This piece is siliconed on top of the two sheets.

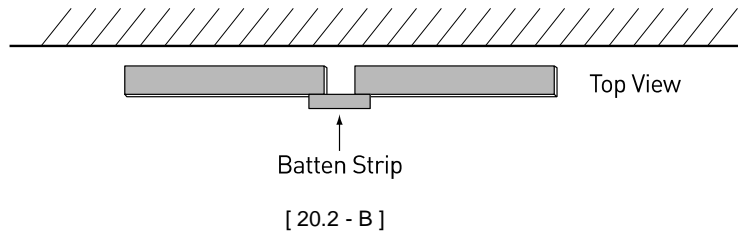

This allows for expansion and contraction.

The batten strip is also the same thickness as the sheets.

Route a 1/8" radius on both long sides.

2. 45° Beveled

The other way is to route 1/8" at 45-degree bevel on the two sheets and sand.

Leave a 1/16" gap when attaching to the wall.

Fill the 1/16" gap with silicone.

Spray with denatured alcohol.

Wipe the joint smooth and clean up.

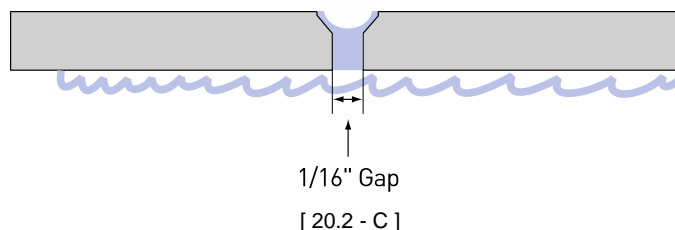

21.1 Food Service Application (Hot Wells)

Try to have all the hot wells next to each other.
Then, keep all the cold wells next to each other.

- Use 6" x 6" corner blocks - 45° all around.
- Make sure to have the corner cut out.
- (High strength corners)



[21.1 - A]

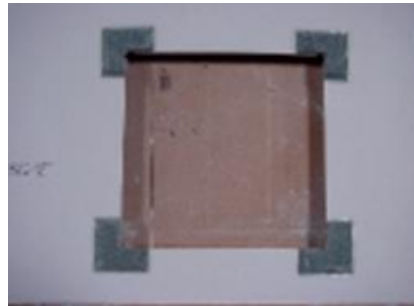

[21.1 - B]

- Round over with 1/8" radius bit and sand smooth.
- 2-3 layers of heat tape- no gaps.
- Multiple hot wells- at least 3" between cutouts.
- Make sure the cabinets have ventilation. Heat needs to be dissipated.
- Round heat wells-Double up all the way around the cutout at least 2" beyond cutout.
- Round over with 1/8" radius, top and bottom. Sand smooth.
- Put heat tape on round holes also.

21.2 Food Service Application (Cold Wells)

Treat cold wells the same as hot wells. The restaurant may decide to switch between the hot wells and cold wells at any time.
It is better to plan ahead.

22.1 Material Preparation

Material preparation is very important for successful thermoforming of Staron®.

1. Cut all pieces to their required dimensions.

➔ **Note**

Allow for material shrinkage and expansion during thermoforming.

2. Sand all material to a matte finish to remove any chips and scratches from edge that may cause tearing during forming. When designing, the minimum inside radius thermoformed as per Staron® thickness is as follows.

Sheet Thickness	Minimum Inside Radius	Remarks
6 mm (¼")	25 mm (1")	Solid, Sanded
	102 mm (4")	Aspen, Pebble
12 mm (½")	76 mm (3")	Solid, Sanded
	127 mm (5")	Aspen, Pebble
	203 mm (8")	Quarry, Talus, Breccia, Metallic

[22.1 - A]

Quarry, Talus, Breccia, Metallic and Tempest are not recommended for thermoforming.

If the sheet is bent to a radius smaller than the above values, the sheet may crack, craze, or whiten externally and / or internally.

22.2 Mold Preparation

Accurate molds must be prepared before heating materials.

Make molds from plywood or M.D.F. board in male / female sections to hold the heated sheet in the desired shape.

1. Cut the male and female mold from good quality plywood or M.D.F. board with a jig saw or router. The mold surface must be smooth and in good quality without any defects to prevent them from transferring onto the face of the Staron® to be thermoformed.
2. The internal part of the male and female molds must be supported to endure pressure.
3. Do not use metal or solid wood, because these materials might absorb heat and slow the thermoforming and cooling process.

22.3 Oven

Having the right oven is essential for thermoforming. The oven has to be heated evenly (homogeneously) to get good result.

- The oven has to be designed for Staron® sheets and be heated to the same temperature at the same time.
- The oven has to be able to fully enclose the sheet. Heat it in a consistent and constant fashion with accurate and predictable control.

22.4 Oven Calibration

Oven must be correctly prepared and calibrated.

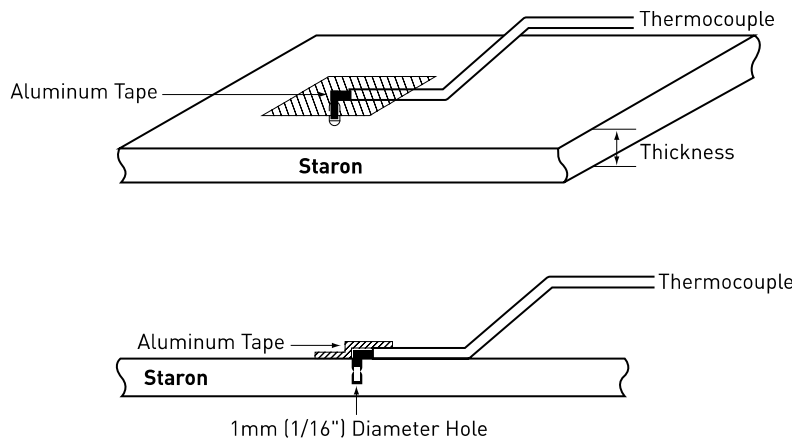

[22.4 - A]

- Drill a 1.5mm (1/16") diameter hole halfway into a test piece of Staron®.
- Insert a thermocouple wire in the hole and the other thermocouple on the surface. The thermocouples should be covered with aluminum tape. To check two different temperatures.
- Check when the temperature in the hole reaches 293~302°F (145-150°C) and on the surface below 320°F (160°C) simultaneously. This will be the most effective time / temperature for your oven.
- Keep this profile during thermoforming.
- When the temperature in the hole reaches 293~302°F (145~150°C) and if the temperature on the surface is higher than 320°F (160°C), the heating power is too strong. Reduce the heating power.
- Remove the piece from the oven and allow it to cool until the thermometer reaches 180°F (82°C).
- Check the cool-down time.

22.5 Thermoforming

Thermoforming of Staron®

Staron® must be heated to a temperature between 293°F(145°C) and 330°F(165°C) for thermoforming. Lower temperatures may crack and whiten the Staron® material and higher temperatures will blister, whiten, or crack the material.

Heat up time will depend on oven design and the size of the piece to be thermoformed.

➔ Note

Uniformly heat the entire piece to prevent problems.

Recommended Time and Temperature guide is listed below.

However, running a test on a scrap piece is highly recommended to find the best time / temperature for the oven.

Sheet Thickness	Oven temperature	Heat up time
6 mm (¼")	302°F(150°C)	30~60 min
	347°F(175°C)	15~30 min
12.3mm (½")	302°F(150°C)	45~80 min
	347°F(175°C)	25~60 min

[22.5 - A]

▶ TIP

Temperature and time may vary depending on the oven.

It is highly recommended to test before final fabrication

22.6 Thermoforming Checklist

- Oven temperature should never exceed 347°F(175°C).
- Oven temperature exceeding 347°F(175°C) may overheat the surface of the sheet causing uneven distribution, causing problems.
- Before thermoforming Staron® sheet, calibrate the oven with a sample piece.
- Pre-heat the oven to the desired temperature.
- Place the piece of Staron® in the oven and start the timer.
- At the end of the calibrated time, remove the piece from the oven.
- Place the piece in the mold and clamp it securely.
- Reset the timer.
- At the end of the calibrated cool-down time, remove the piece from the mold and keep it under the atmosphere to cool to room temperature.

23.1 Introduction

The following Repair Techniques have been designed and compiled by Kevin Andreas of TEMPLATES BY ANDREAS. For any questions or to purchase tools described in the following repair section, please contact TEMPLATES BY ANDREAS directly.

The information and statements are believed to be reliable by both LOTTE ADVANCED MATERIALS and TEMPLATES BY ANDREAS.

However, it does not construe to assuming responsibility of any kind. Please undertake sufficient testing to determine suitability. LOTTE ADVANCED MATERIALS and TEMPLATES BY ANDREAS disclaim any responsibility.

It is important to test and take any necessary precaution to make sure the methods and products described are suitable to the user's specific needs.

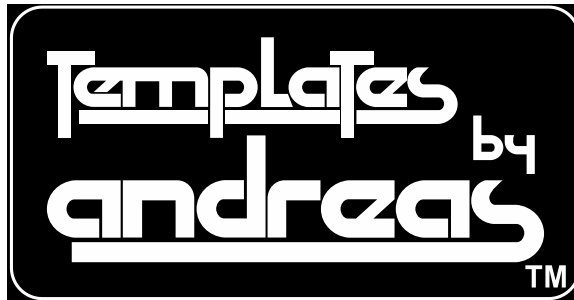

80 Black Meadow Road
Chester, NY 10918
1-800-935-5406

23.2 Inside Corner Repair

Inside Corner Repair

1. Sand the area to be repaired.
2. Encompass damaged area with pie shaped template and raise template with ¼" plywood shims.
3. Clamp to deck.
4. Using a 1" template guide and a ½" straight bit, rout through the deck only (leave onion skin of material).
5. Use wide router base to remove deck over buildup area.
6. Rout bevel into deck (deck thickness only) using bevel bit as shown.
7. Remove template.
8. Using plug template, mark a line on the buildup (this line will be ¾" over).
9. Slide template to line it up with the marks (no ¼" shims are needed.)
10. Using 1" template and ½" flute bit, route through damaged buildup.
11. Remove template
12. Hot melt 2 pieces of repair material (one at a time) to plug template and rout with 1" straight bit with bearing.
13. Slide repair buildup pieces into buildup and mark out backside to line up with existing buildup.
14. Either cut buildup repair pieces to exact size using 1" top bearing bit and two 1" x 2" strips hot melted to pieces (this will leave a ½" radius at the inside corner) or rough cut pieces a ¼" over size with a jigsaw.
15. Make your deck plug the same as in steps #6 & #7 in Bevel Repair.
Each repair will act as seam plate to one another. All seams are 1" off the radius as required.
16. Glue up and sand.

Inside Corner Repair - Step by Step

1. Sand area to be repaired.
2. Encompass damaged area with pie shaped template and raise template with ¼" shims and clamp to deck.
3. Using 1" Template Guide and ½" straight bit, rout through deck only (leave onion skin material). Use wide router base to remove deck over buildup area.
4. Rout bevel into deck (deck thickness only) using bevel bit as shown.

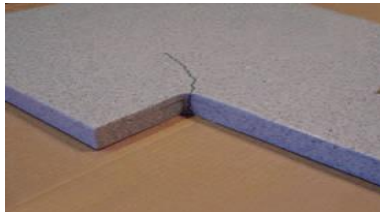

(1) Inside corner crack

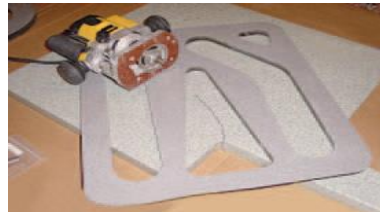

(2) Encompass damaged area



(3) Rout with 1/2" straight bit/1" guide



(4) Rout bevel into counter

[24.2 - A]

5. Remove template. Deck is ready.
6. Using plug template, mark a line on buildup (this line will be ¾" over).
7. Slide template to line up with marks (no shims needed).
8. Using 1" template and ½" single flute bit, rout through damaged build-up (as shown).



(5) Remove template

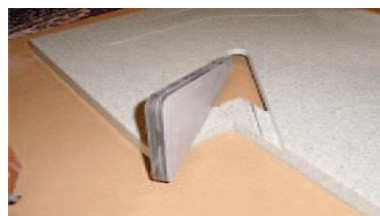

(6) Mark out build up



(7) Line up template to marks



(8) Rout out cracked build up

[24.2 - B]

Inside Corner Repair - Step by Step

9. Remove template. Countertop is now ready.
10. Hot melt 2 pieces (1 at a time) of repair material to the plug template and rout with 1" top bearing straight bit.
11. Slide repair buildup piece into buildup and mark out (2 pieces).
12. Cut new buildup pieces even with existing buildup in rear while leaving a 1/4" extra in the front.



(9) Remove template, counter is now ready



(10) Rout build up repair plug-2



(11) Fit and mark out plug



(12) Cut plug to size

[24.2 - C]

13. Make your deck plug the same as in step # 5 of the Bevel Repair, using the correct template. The buildup is repaired using a horizontal bevel, while the deck is repaired using a vertical bevel. Each repair will act as seam plate for one another. All seams are 1" off the radius as required. Glue up and sand.



(13) Mark top plug and glue up

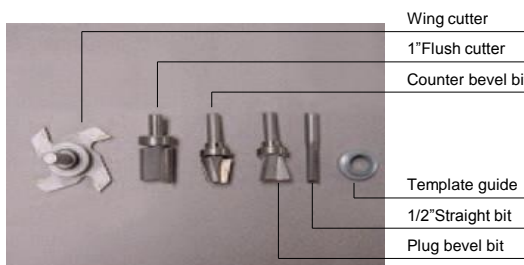

Repair template



For counters

For plugs

[24.2 - D]

23.3 Bevel Repair

Bevel Repair

1. Sand the area to be repaired so that all dirt/grease, etc. is removed.
2. Encompass entire crack with template. Attach template to deck using 4 dime size dabs of hot melt or by hot melting blocks around template to hold in place.
3. Rout out damaged area using a 1" template guide and $\frac{3}{8}$ " or $\frac{1}{2}$ " straight flute bit.
4. Using the counter bevel bit, rout opening of template. Allow bearing to have $\frac{1}{8}$ " to $\frac{1}{4}$ " coverage on template.
5. Remove the template with denatured alcohol and a chisel or putty knife.
6. Take the color matched repair piece along with matching plug template and hot melt them together with the good side up.
7. Cut the repair piece $\frac{3}{8}$ " bigger than the template.
8. Mount a plug bevel bit into the router table. Take the repair template with the color matched repair piece hot melted to it and place it on to the router table with the template side resting on the router table.
Raise the bit up so bearing is within $\frac{1}{8}$ " of the repair piece and let the template ride on the bearing.
9. With the templates still attached to the plug, place the plug in the counter.
If it is too high, lower the bit in the router table and re-route the plug, repeating the process until the plug fits flush with the countertop.
10. Remove the template from the plug as in step #5.
11. Clean all surfaces to be glued with denatured alcohol using clean white cloth.
12. Place aluminum tape on the underside of the counter cutout to stop glue from dripping.
13. Place aluminum tape on the good side of the plug with a 1" overhang to stop glue from dripping.
14. Apply glue to the plug and then the opening.
15. Place plug in opening pressing down firmly.
(No clamping is required or recommended since clamping may cause the piece to shift or build stress into the repair.)
16. Remove tape from plug and check for flushness with deck.
Plug should fit the same as it did when it was dry fitted as in step #9.
17. Let adhesive cure and sand repair area flush with 80-grit sandpaper.
18. Once flush, change sandpaper to achieve desired finish.

Bevel Repair - Step by Step

1. Sand area to be repaired so all dirt / grease, etc. is removed.
This will allow clean seams / hot melt will hold templates better.
2. Hot melt template with 4 dime size dabs of glue to counter so crack is encompassed and rout using a 1 Template Guide and a 3/8" or 1/2" flute bit (leave template on).
3. Using alternate bevel bit (as shown) to route opening of template. Allow bearing to have 1/8" to 1/4" coverage on template.



(1) Hot pot cracks

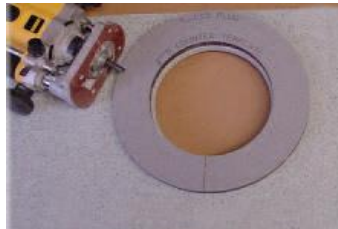

(2) Rout out damage with 1/2" straight bit/1" template guide

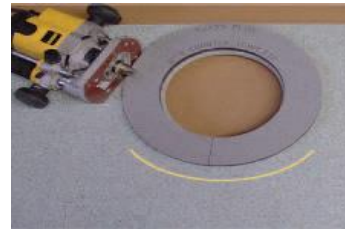

(3) Rout bevel into counter

[24.3 - A]

4. Remove template with denatured alcohol and chisel or putty knife.
5. Take color match piece and the matching plug template hot melt together both parts good side up.
Cut repair piece 3/8" bigger than the template (jigsaw ok).
6. Raise bit up so bearing is within 1/8" of repair piece and let template ride on bearing.
(This makes plug as big as possible, you can always make it smaller.)

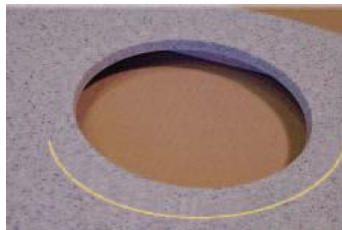

(4) Remove template and counter is ready



(5) Cut repair piece 3/8" bigger than template hot melt together



(6) Rout plug on router table

[24.3 - B]

7. With template still on plug test in counter. If it is too high, just lower bit in router table. This will make the plug smaller.
Repeat until plug is flush with top.
8. Remove template from plug. Clean all surfaces with white rag and denatured alcohol. Place aluminum tape on underside of counter cut out to stop glue from dripping, and place aluminum tape on good side of plug overhang 1" to stop glue from dripping. First apply glue to plug, then opening. Place plug in opening remove tape from plug and check for flushness with deck (no clamping required) just like a bevel mount sink.



(7) As you lower bit plug will become smaller

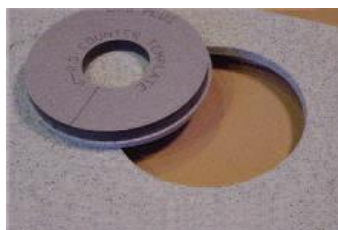

(8) Test plug for flushness with deck than glue up

[24.3 - C]

23.4 Solid Surface Sink Replacement

Solid Surface Sink Replacement

The following directions are for the removal of an average 16" x 21" sink using the Andreas Dustless Sink Template. Using this system the removal of the sink is virtually dustless. The template allows the fabricator to come within 1" of any obstruction, which means in most cases the top does not need to be removed.

The process takes between 2 ½" - 3 hours.

Solid Surface Sink Replacement - *Step by Step*

1. On the deck surface, measure back 1 from the inside of the sink on all 4 sides.
2. Center the appropriate Andreas Dustless Sink template between the marks.
3. Hot melt # ½" x 1" x 6" blocks around the template to hold it in place.
4. Secure the sink in place with a pipe clamp as shown in figure 24.4-A.
5. Tape off outside of counter / cabinet with blue painters tape (painters tape won't ruin the finish on the cabinets) to help control dust leakage from door cracks and other openings.
6. Use pipe foam to block the space between the top of the cabinet and the underside of the counter.



[24.4 - A]

7. Using a Dewalt #625 Router or equivalent set at 8000 RPMS (the router must be set at 8000 RPMS due to the size of the blade to insure safety and quality of the cut) insert the Andreas 6" dustless sink removal bit and the 5/8" template guide (figure 24.4-B) and align the blade to the seam as shown in figure 24.4-C.
8. Spray the blade with cutting lubricant and rout the backside of the sink first, keeping firm downward pressure on the router at all times.
9. Look at the shaft of the bit to insure the blade has completely stopped spinning then remove the router from the template.
10. Remove the template from the counter.
11. Vacuum dust from around the bottom of the template.



[24.4 - B]



[24.4 - C]

Solid Surface Sink Replacement - Step by Step

12. Apply aluminum tape around the back half of the sink seam that was just cut.
(This will hold the sink in place and prevent the sink from pinching the blade on the final sink cut).
13. To remove the front of the sink, turn the sink template 180 degrees and place it back on the countertop.
14. Cut out front of sink (router can move in a forward or backward direction due to its multi tooth design).
15. Again, look at the shaft of the bit to make sure that the blade has completely stopped spinning and then remove the router and the template.
16. Vacuum the template, the sink and the sink cabinet.
17. Remove old sink and inspect the cut where the sink was removed from the counter to insure a smooth cut and that all old flange has been removed.
18. Take the new sink and run aluminum tape 1/16" down from the edge of the bowl, under where the seam line is going to be.
19. Turn the tape up at a 90 degree angle to act as a gutter to catch excess glue from seaming.
20. Add the 8" extension and the donut to the pipe clamp setup as shown in figure 24.4-D.
21. Place the new sink onto the pipe clamp setup and raise it into the underside of the sink opening.
22. Place web clamps the counter over the sink and snug the new sink to counter making sure it is centered in old sink opening.
23. Clean dust off the surface, and then place sink clips around the sink at the web clamp openings with a generous amount of hot melt (figure 24.4-E and 24.4-F).



[24.4 - D]



[24.4 - E]

24. Remove the web clamp and lower the sink.
25. Clean the surface of the sink and the cutout.
26. Apply " bead of seam adhesive to the sink flange approximately 1/4" from the outside of the flange.
27. Raise the bowl back into the opening (sink clips will guide the bowl in exact location as before).
28. Replace web setup and tighten the clamp until a 1/8" + deflection is in the web clamp (figure 24.4 - F).
29. After adhesive is cured remove sink clips with denatured alcohol and sand with a Festool Rotex sander placed on direct drive with 80 grit sandpaper.
30. Switch the Festool Rotex sander back to random orbital drive and finish off with finer sandpaper as needed.

Changing a double sink will require two pipe clamp setups along with a double sink template and the appropriate web clamp.



[24.4 - F]

24.1 Recommended Tools

Recommended Tools

The following Suppliers, Manufacturers, and Tool Lists are included in this manual for your convenience. It is important to understand that other manufacturers may offer similar equipments.

Please undertake sufficient testing to determine suitability. LOTTE ADVANCED MATERIALS disclaim any responsibility.

It is important to test and take any necessary precaution to make sure the products described are suitable to the user's specific needs. The following list was constructed with Fabricators to define must have tools.

Please note, the list is in a random order.

- **MONUMENTTOOLWORKS, INC**
508-644-2400



Monument Tool works manufactures the PARALIGN seam leveling clamp, vacuum grip straight edges and templates, sink vacuum clamps, and many other unique tools for solid surface fabricators.

- **FESTOOL**
805-968-0408



FESTOOL makes superior power tools that help trades people work faster, easier, more profitably and more accurately than ever before. FESTOOL provides a complete system, from high-performance dust extraction to long-life consumables.

For solid surface work and fabrication, FESTOOL makes the job easier for the discriminating professional. In quality, design, and ergonomics, there is nothing else like it.

- **DANI DESIGNS**
248-852-9248



Over the past 30 years Dani has always taken pride in producing the highest in quality for all the products produced.

Dani Clamp system is by far the fastest and most efficient way to clamp solid surface countertops.

Dani Designs has clamp sets for clamping edge treatment, sinks, cove backsplashes, deck seams, and backsplashes.

In addition, Dani Designs product line includes polishing system, special sanding pads, Cox adhesive dispensers, and more.

- **Protect All Inc.**
800-322-4491



Protect All Shine plus, Solid Surface Cleaner, Polish, Wax and Treatment is the solid surface care kit in a can.

Spray and wipe dry, to a beautiful finish. Regular use aids in preventing scratches and makes future care and maintenance easier and quicker. Finally, solid surface care simplified.

- **WESTLEY TOOLS LTD.**
800-397-6867



Wesley Tools offers a complete line of tooling for solid surface.

No matter what Staron® sink or bowl you are installing they have the cutting tools to make the fabrication easier, faster and more precise.

- **PINSKE EDGE**
800-T-PINSKE



The Pinske Edge manufactures quality tools for solid surface fabricators.

Our full line includes power grips, squares, straight edges, templates, coved backsplash equipment, thermoforming ovens, sanding equipment, seaming methods, shop carts, repair systems, material handling products, decorative inlays, hot rods, instructional videos, fabrication seminars, and much more.

- **EVERLAST SAW**
239-596-3333



Everlast Saw is an innovator in carbide tipped router bits and circular saw blades for solid surface. Blades range from 7" to 20" and include millimeters. No sanding or polishing needed on saw cuts.

- **AMERICAN CLAMPING CORP.**
585-344-1160



Bessey clamps from American Clamping. Clamps designed for solid surface including PS-55 seaming tool, V-grooving corner clamp, back-splash and Klemmy clamps.

- **ART BETTERLEY ENTERPRISES**
800-871-7516

Specialty tool for solid surface and plastic laminate fabrication.

- **COLONIAL SAWCOMPANY**
781-585-4364



Colonial Saw is the North American distributor of Striebig vertical panel saws, the Swiss made saws legendary for their efficiency, seamable cut quality, and durability in the solid surface industry.

The Optisaw 2 has long been the standard in the industry with hundreds of them in fabrication shops.

Two new models, the Evolution and Control, offer the ultimate in operator ease and efficiency in vertical panel sawing.

- **GEM INDUSTRIES, INC.**
800-447-4GEM



GEM manufactures the 11" orbital sander which comes with 3M Hook-it II system. The sander uses 3M Micron paper. Trizact and Scotch Brite.

- **PERFORMANCE ABRASIVES**
513-733-9283



Manufacturer of sanding discs and belts. Products include the patent binding wavy edge and Donut O'brasive sanding discs. Your one stop abrasive shop

- **AMPS**
978-568-1127



AMPS Interlocking Straight Edges product. Durable 10 MM Phenolic Core. Light weight. Will not scratch like aluminum. Quick and easy to connect. Uses just (2) clamps for " L " shaped counter. Supports continuous routing. Custom templates available. Stock Radius 90DG to 6"

- **AXIOM LTD**
716-894-5240



Axiom 25, a premium line of translucent silicone developed for the solid surface industry is available in beige, blue, charcoal, gray, green, rose, and white.

- **AXYZAUTOMATION, INC**
888-299-8840



The XYZ's #7012 CNC router table is an innovative CNC unit designed specifically for the solid surface fabricator. Featuring another industry first, the XYZ's #7012 comes equipped with an 8" dynabrade random orbit finishing sander as a standard feature.

- **SUR-CARE USA, INC.**
925-455-1270

Innovative solutions for finishing technology. Manufacturer of the revolutionary Surecare SMF-200 sander and Microfinisher and the Quick Grit change system for accessory finishing pads.